

# Help guide

MP-CL1

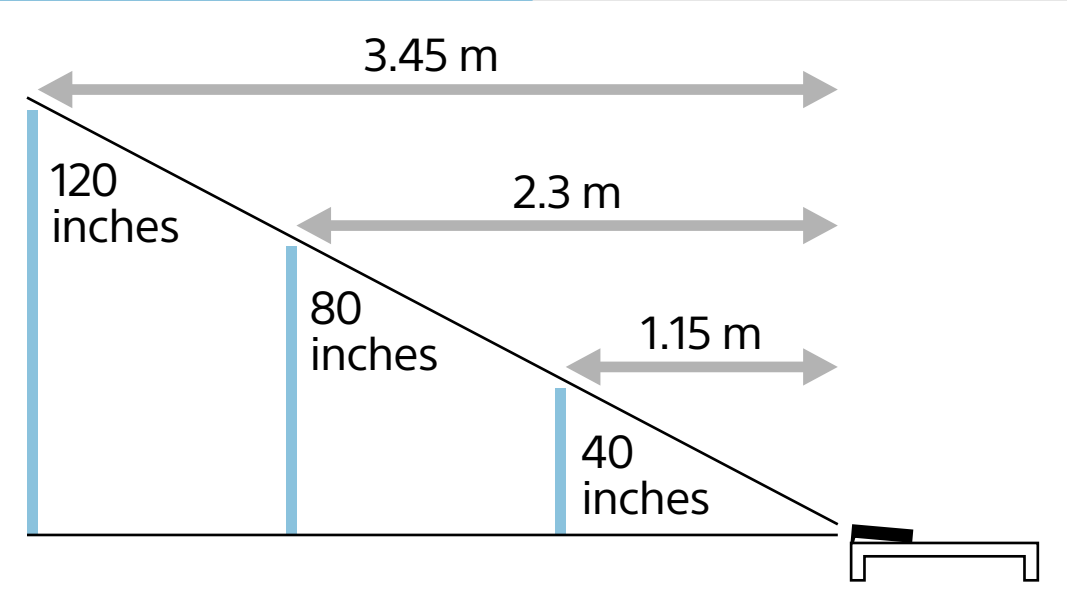
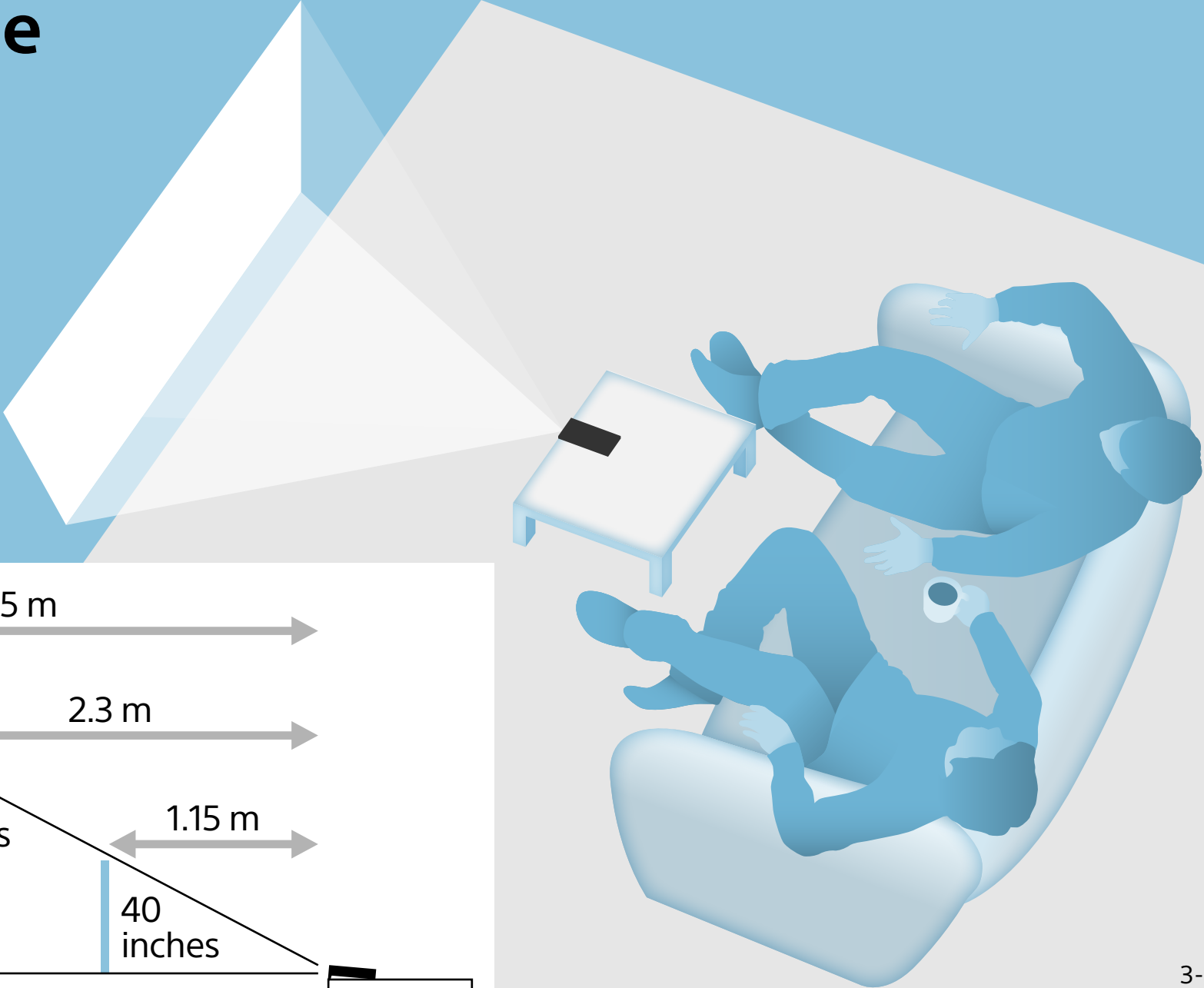

# Parts and controls

## CAUTION

Do not point the laser light directly at eyes or people, nor look into it. Doing so may cause serious injuries such as loss of eyesight.

**1** Strap hole

**2** Micro USB jack

Use an AC power adaptor with a 1.5 A or greater output to charge this product.

**3** ⏻ (power) button

Press and hold the ⏻ (power) button for longer than 1 second to turn the power on or off.

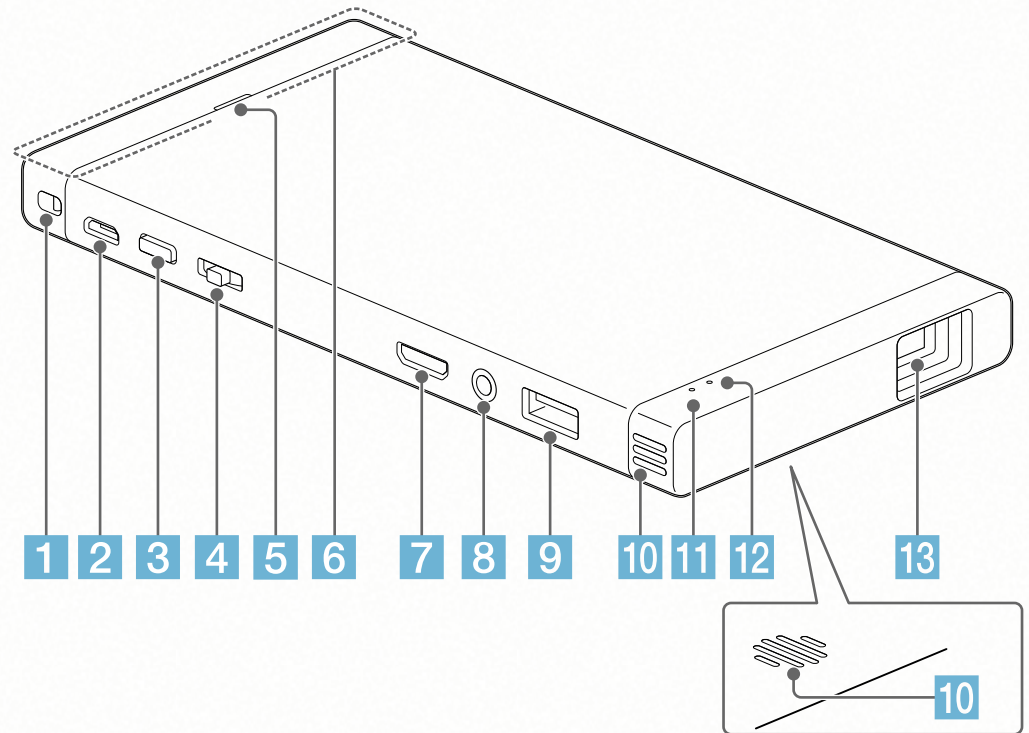

#### 4 Jog lever (-/ENTER/+)

Press the jog lever while at the ENTER position to display the menu. Slide it to + or - to move to next or previous menu item, and then press while at the ENTER position to select the highlighted item.

#### 5 Speaker

#### 6 Built-in Wi-Fi antenna

#### 7 HDMI/MHL IN jack

#### 8 AUDIO OUT jack

Connect headphones or speakers to this jack.

#### 9 USB OUT jack (for power supply)

Connect another device to this jack to charge it. The  lamp lights up in green while charging the device.

#### 10 Ventilation holes

#### 11 (charge) lamp

#### 12 (power) lamp



#### 13 Lens

Laser radiates from this aperture.

## Adjusting the volume

Slide the Jog Lever to + or – while the menu is not displayed to adjust the volume.

## Checking the remaining battery power

Press and quickly release the  button (within 1 second). The  lamp blinks in orange, showing the battery status. The lamp blinks in one of the following patterns according to the remaining battery power.

 · · ·  · · · (Once): 0% to 30% remaining

  · ·   · · (Twice): 30% to 70% remaining

   ·    · (Three times): 70% to 100% remaining



# Using the menu

---

## Navigating the menu

Learn how to navigate through the menu here.

- 1 Press the jog lever while at the ENTER position.**

The menu is projected.

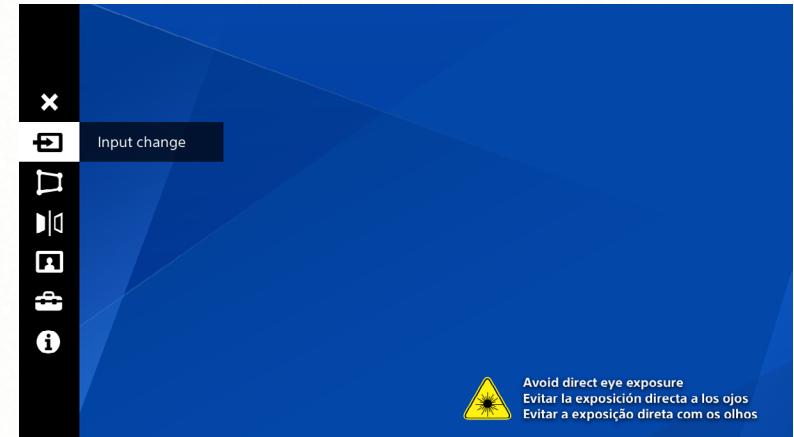

- 2 Slide the jog lever to + or – to move to the next or previous menu item.**

- 3 Press the jog lever while at the ENTER position with the desired menu item highlighted.**

One of the following is displayed according to the selected menu item.

## Values to choose from

Slide the jog lever to + or – to move to the next or previous value, and then press the lever while at the ENTER position with the desired value highlighted.

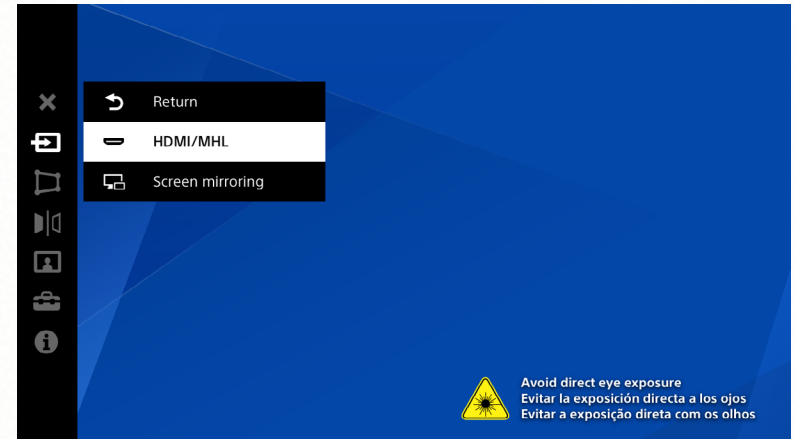

## Submenu

Slide the jog lever to + or – to move to the next or previous submenu item, and then press the lever while at the ENTER position with the desired item highlighted. The adjustment bar or another screen is displayed according to the selected item.

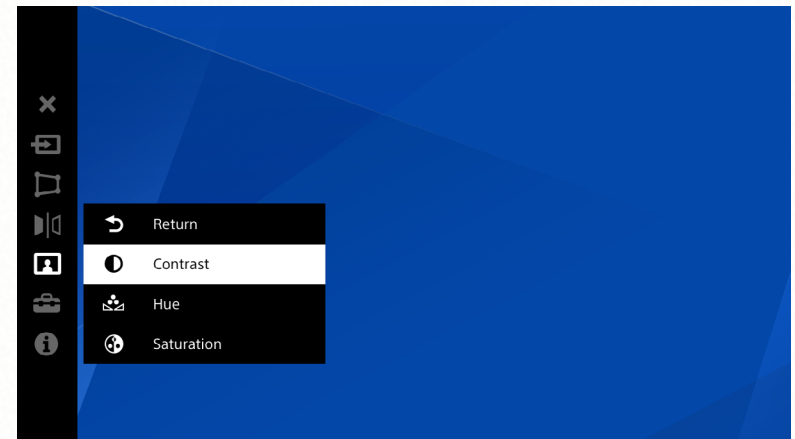

## Adjustment bar

Slide the jog lever to + or – to change the value shown in the bar, and then press the lever while at the ENTER position to confirm.

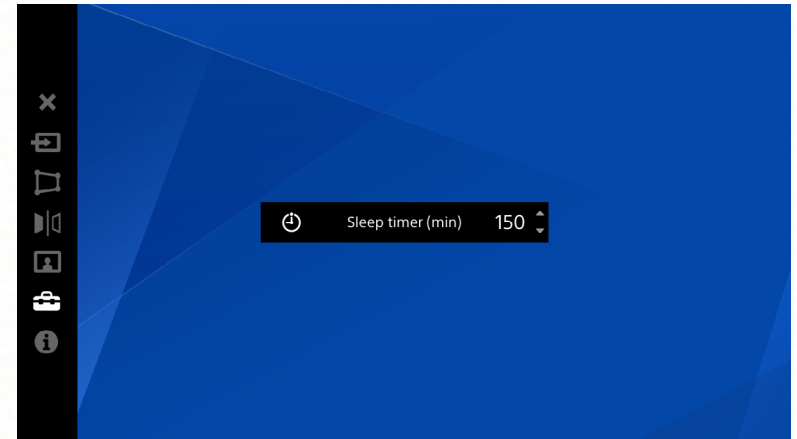

## To exit the menu

Press and hold the jog lever for about 2 seconds while at the ENTER position.

# Description of the menu items

---

✕ Close Exits the menu.

---

☒ Input change Selects an input source from HDMI/MHL and screen mirroring according to the connection method.

---

## ☒ Keystone

☒ Keystone Preset 1/  
Preset 2/  
OFF

If the projected image is distorted and looks trapezoidal, select [☒ Keystone Preset 1] or [☒ Keystone Preset 2] to apply the keystone adjustment. The default values of [☒ Keystone Preset 2] is suitable for correcting distortion when using the 2 Way Stand (supplied). The preset values can be customized by changing the settings in [☒ V keystone] and/or [☒ H keystone] below.

---

☒ V keystone Corrects vertical distortion. The value set here overwrites the selected preset value.

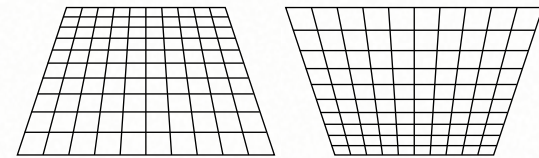



---

## H keystone

Corrects horizontal distortion.  
The value set here overwrites the selected preset value.

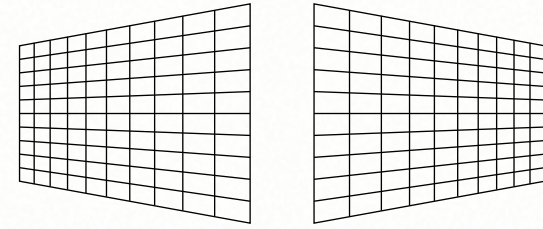

---

## Flip (left-right)

Flips the image horizontally. Use this mode for rear projection. To flip the image back to normal, select this menu again.



---

## Picture setting

Contrast Adjusts the contrast of the projected image.

---

 Hue Adjusts the color tones.





---

Saturation Adjusts the color intensity.

---

---

## Setup

 <b>Device name</b>	Displays the device name of this product. You can change the name (up to 15 characters) by selecting the name field and using the on-screen keyboard. Select [Save] to save the new name.
 <b>Sleep timer</b>	Turns this product off automatically after a set length of time up to 150 minutes in increments of 30 minutes.
 <b>Optical alignment</b>	Adjusts the horizontal/vertical alignment of the color items. Try this if the projected image is unclear.
 <b>Biphase alignment</b>	Adjusts the synchronization timing of input signals. Try this if the projected image is flickering or blurred.
 <b>Factory reset</b>	Resets all setting values (except for the Optical and Biphase alignment settings) to the factory default.

---

---

**↻ Software  
update**

Updates the software of this product when there is a software update available. Visit the website at <http://www.sony.net/SonyInfo/Support/> for details.

---

**ⓘ Information**

Displays the Help guide (this document) and other important information.

---

# On-screen keyboard

The keyboard is displayed on the screen when the text box is selected in the [Device name] screen. Slide the jog lever to + or – to move through the keys, and then press the lever with the desired key highlighted.

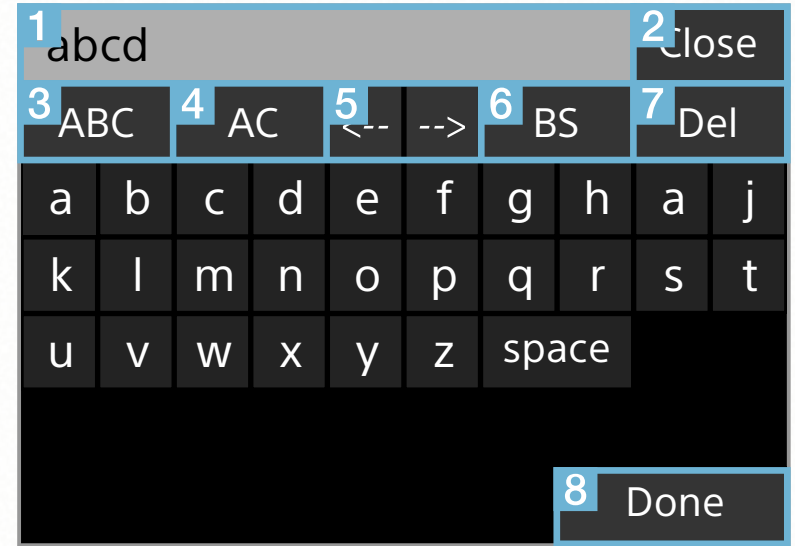

---

<b>1</b> Text field	Displays the input text.
<b>2</b> Close	Closes the on-screen keyboard without saving the input text.
<b>3</b> 12#/ABC/abc	Switches the input mode. You can also switch the input mode by pressing the jog lever for more than 2 seconds while another key is highlighted. [12#]: Numbers, punctuation and symbols [ABC]: Capital letters [abc]: Small letters

---



---

<b>4</b> AC	Clears the text field.
<b>5</b> <---/-->	Moves the cursor left or right.
<b>6</b> BS	Deletes characters to the left of the cursor.
<b>7</b> Del	Deletes characters to the right of the cursor.
<b>8</b> Done	Saves the input text and closes the on-screen keyboard.

---

# Connecting via screen mirroring

---

Connect this product to a device capable of screen mirroring and project its screen.

- 1 Select [🔌 Input change] - [🖥️ Screen mirroring] in the menu of this product.**
- 2 With your device capable of screen mirroring search for connectable devices.**  
A list of connectable devices is displayed.
- 3 Tap the Device name of this product (MP-CL1) in the list.**

#### 4 Select [↵ Return] - [✕] to exit the menu.

The screen of the device capable of screen mirroring is projected.  
Operate the device to select the content that you want to project.

##### Note

- The operation for searching for this product using the screen mirroring function differs depending on the device. Refer to the manual of your device for details.
- The screen mirroring function may be also referred to as “Miracast,” etc.

# Connecting via HDMI cable

---

Connect this product with an HDMI-compatible device such as a computer, PlayStation or video device, and then project its content.

- 1 Connect this product and the HDMI-compatible device using the HDMI to Mini HDMI converter adaptor (supplied) and an HDMI cable (not supplied).**
- 2 Select [Input change] - [HDMI/MHL] in the menu of this product.**
- 3 Select [Return] - [x] to exit the menu.**  
The screen of the HDMI-compatible device is projected.  
Operate the device to select the content that you want to project.

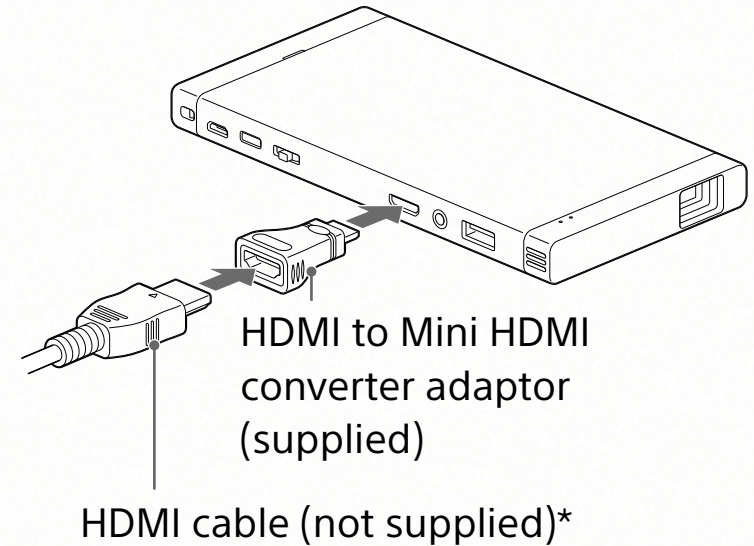

\*Use the supplied converter adaptor as necessary.



# Connecting via MHL

Connect this product with an MHL-compatible device such as a smartphone or tablet, and then project its content.

- 1 Connect this product and the MHL-compatible device using an MHL to HDMI adaptor (not supplied), the HDMI to Mini HDMI converter adaptor (supplied) and an HDMI cable (not supplied).**
- 2 Select [Input change] - [HDMI/MHL] in the menu of this product.**
- 3 Select [Return] - [X] to exit the menu.**  
The screen of the MHL-compatible device is projected.  
Operate the device to select the content that you want to project.

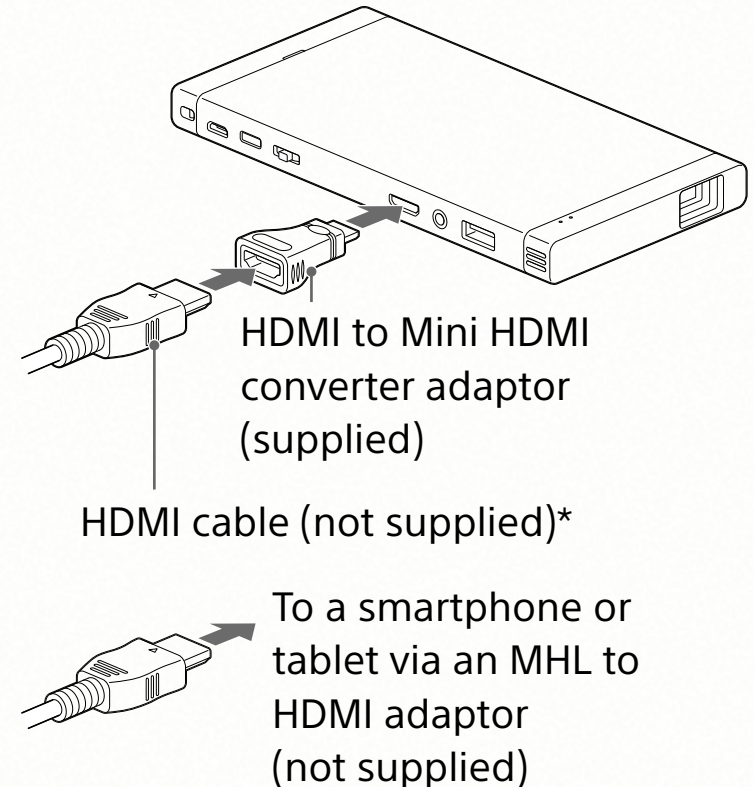

\*Use the supplied converter adaptor as necessary.

## Note

- To supply power to the connected device during an MHL connection, connect this product to a wall outlet to charge with the USB cable (supplied) and a USB power adapter (not supplied). Note, however, that the remaining battery power of this product may decrease even while charging depending on the connected device.

# Alignment settings

## Optical alignment

Adjust the horizontal/vertical alignment of the color items to obtain a clear image. If colored lines are seen beside the crossed lines in the [Optical alignment] screen, the color items corresponding to those colors need to be adjusted.

### 1 Select [Setup] - [Optical alignment].

The [Optical alignment] screen appears. To select an item in the screen, slide the jog lever to + or -, and then press the lever with the desired item highlighted.

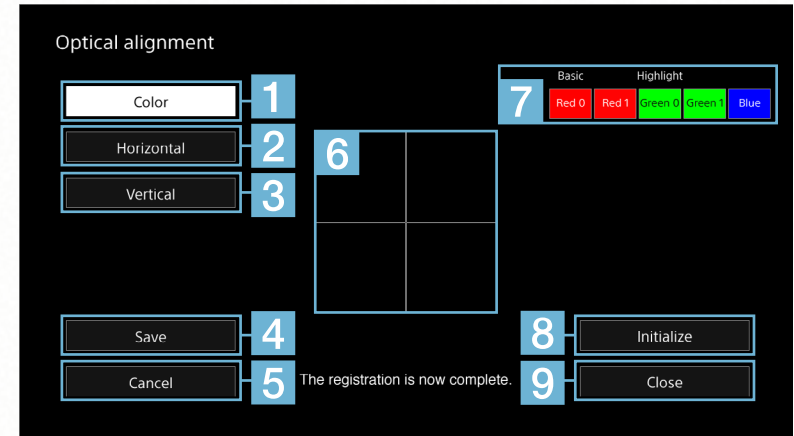

### 2 Select [Color] (1) to select the color item (7) to adjust.

One of the color items is automatically set as [Basic], which is used to align the other items.

[Highlight] is shown above the color item that is currently selected for adjustment. To select the next or previous color item, slide the jog lever to + or -, and then

press the lever with the desired item highlighted.

**3 Select [Horizontal] (2) or [Vertical] (3) to adjust the horizontal/vertical position of the selected color item.**

Slide the jog lever to + or – to move the position, and then press the lever when you have finished adjusting.

To adjust both horizontal and vertical positions of the same color item, repeat this step.

**4 Repeat steps 2 and 3 to adjust other color items as necessary.**

**5 When you have finished adjusting, select [Save] (4) to save the new values.**

**6 Select [Close] (9).**

The [Optical alignment] screen closes.

**To revert to the most recently saved values**

Select [Cancel] (5).



## To revert to the default values

Select [Initialize] ( **8** ).

# Biphase alignment

Adjust the synchronization timing of the input signals if the projected image is flickering or blurred. If the three white vertical lines at the center of the [Biphase alignment] screen look blurred, you need to perform the following procedures.

## 1 Select [Setup] - [Biphase alignment].

The [Biphase alignment] screen appears. To select an item on the screen, slide the Jog Lever to + or -, and then press the lever with the desired item highlighted.

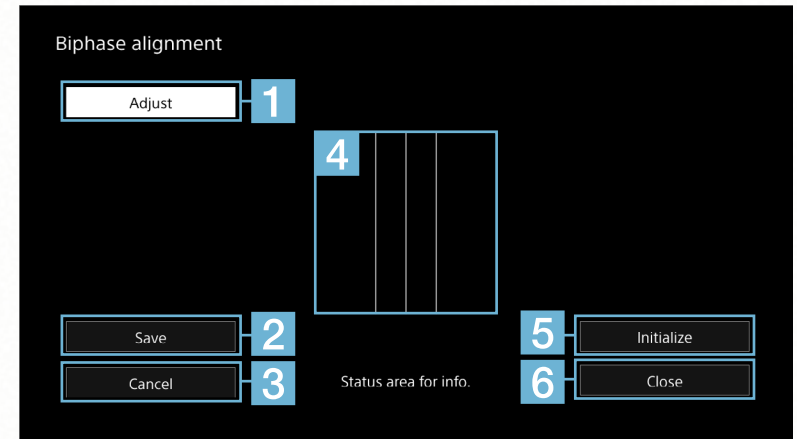

## 2 Select [Adjust] (1).

3 Slide the jog lever to + or - so the three lines (4) look clear without blur. Press the jog lever when you have finished adjusting.

4 Select [Save] (2) to save the new value.

**5** Select [Close] (**6**).

The [Biphase alignment] screen closes.

**To revert to the most recently saved value**

Select [Cancel] (**3**).

**To revert to the default values**

Select [Initialize] (**5**).

# Troubleshooting

---

## Operation

### **This product does not charge.**

- The USB OUT jack can only be used to supply power to other devices, and it cannot be used to charge this product. Be sure to use the Micro USB jack to charge this product.

### **The fan is noisy.**

- This is not a malfunction. When the ambient temperature is high, the fan noise becomes louder.

### **No images are projected.**

- Check that the input source is selected correctly in the [ Input change] menu.
- Check that the cable, connector and/or adaptor are connected correctly for wired connection.
- Some image formats may not be available depending on the connected device or the connection method.

### **There is no sound.**

- Check the volume level of this product and the connected device.





**The  lamp blinks in red while charging another device via the USB OUT jack.**

- The battery of this product is almost depleted.
  - The USB cable (supplied) may not be connected correctly. Disconnect it and reconnect.
  - The specifications of the connected device may not meet the requirements. Check the charging specifications of the device.
- 

## Picture

**The image is flickering or blurred.**

- The synchronization timing of the input signals may need to be adjusted. Select [ Setup] - [ Biphase alignment] in the menu and adjust the timing.

**The image is a trapezoidal shape.**

- Move this product to adjust the projection angle.
- Correct the distortion electronically in the [ Keystone] menu.

**The image is reversed.**

- Select [ Flip (left-right)] in the menu to flip back the image.

### **The projected image is unclear.**

- Go to the [🔍 Optical alignment] and/or [📏 Biphase alignment] menu and perform adjustment.

### **The image is too dark.**

- Adjust [🔆 Contrast] and [🌈 Saturation] in the [👤 Picture setting] menu.

### **The color does not look appropriate.**

- Adjust [🌈 Hue] and [🌈 Saturation] in the [👤 Picture setting] menu.
- 

## **Connection**

### **The image is not projected smoothly via screen mirroring.**

- Check that the Wi-Fi antenna parts of this product and the connected device are not covered by your hands, etc.
- Remove obstacles between this product and the connected device, and place them closer to each other.

### **A connection via screen mirroring cannot be established.**

- Check that the Wi-Fi antenna parts of this product and the connected device are not covered by your hands, etc.

- The Wi-Fi function of the device capable of screen mirroring may need to be turned off when using the screen mirroring function. Refer to the manual of your device for details.

If the problem still persists after performing the suggested remedies, contact your nearest Sony dealer.



# Important information

---

## Notes on use

- The USB OUT jack of this product is for output only. Do not connect this product to a USB jack of a computer or other device. Doing so may cause malfunction.
- If the lens is not clean, wipe it with a soft cloth such as eyeglass cleaner cloth.
- Do not use or store this product in a humid or dusty place.
- Remove cables from this product after use or while not in use.
- Check the connections of this product periodically to make sure dust does not accumulate.
- The antenna is built in to this product. Do not cover the antenna part with your hands, as doing so may affect the communications quality.
- Do not place this product close to credit cards. Doing so may result in the loss of recorded data.
- Noise may be heard on nearby TVs, radios or tuners while using this product. If this happens, use this product away from these products.
- When charging this product while projecting images, the remaining battery power of this product may decrease depending on the usage environment.