

SONY®

PS2®

PlayStation®2

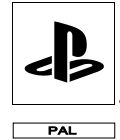

Instruction Manual

Thank you for purchasing the PlayStation®2 computer entertainment system.

You can play PlayStation®2 format CD-ROM and DVD-ROM discs, PlayStation® format CD-ROM discs, audio CDs, and DVD video and DVD-RW (VR mode) discs with this system.

Before operating this console, please read this manual carefully and retain it for future reference.

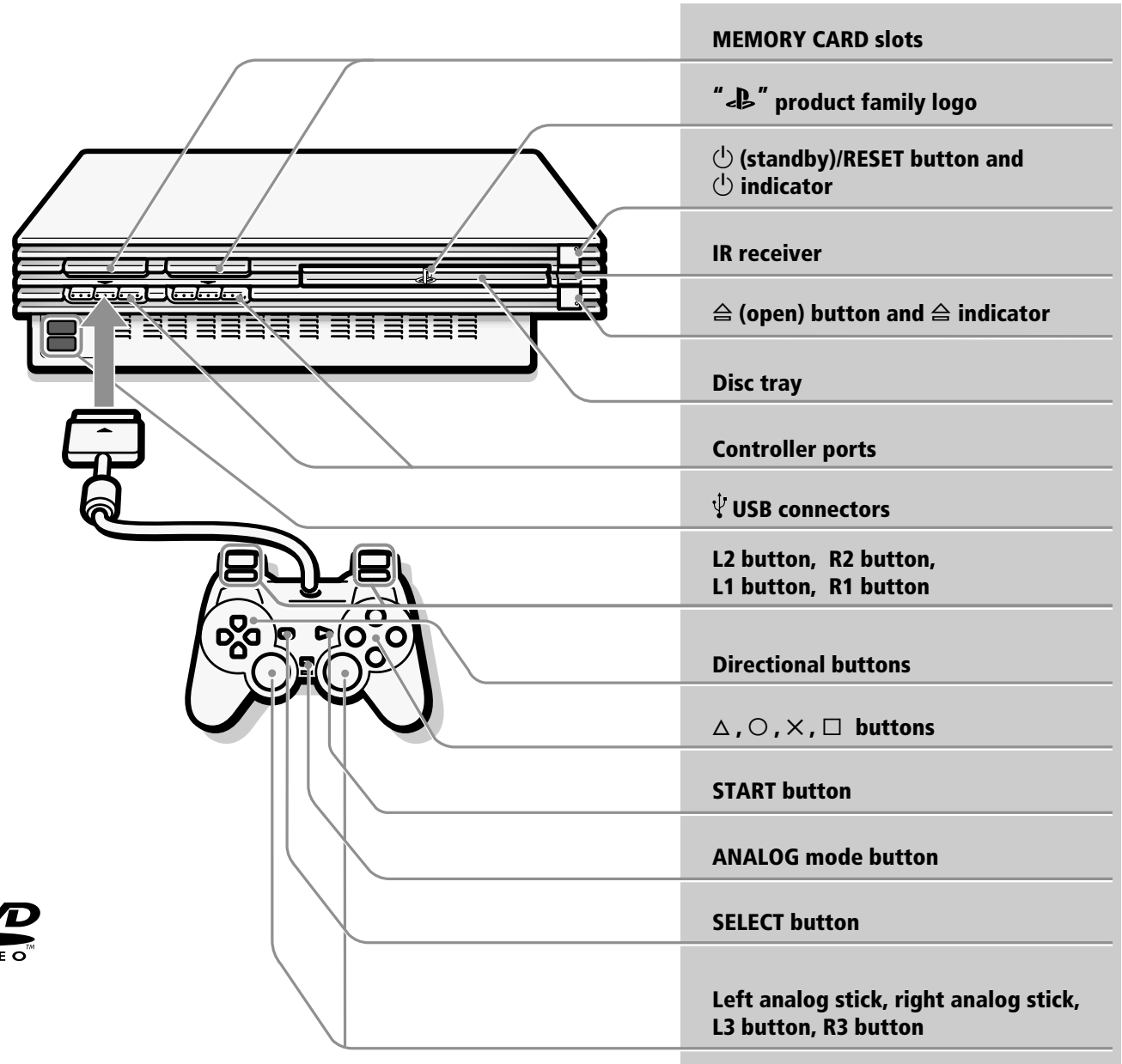

SCPH-50002



WARNING

To prevent fire or shock hazard, do not expose the console to rain or moisture.

To prevent fire or shock hazard, do not place a container filled with liquids on top of the console.

To avoid electrical shock, do not open the cabinet. Refer servicing to qualified personnel only.

Caution

The use of optical instruments with this product will increase eye hazard. As the laser beam used in this unit is harmful to eyes, do not attempt to disassemble the cabinet.

Refer servicing to qualified personnel only.

Read carefully before operating your PlayStation®2 console

A few people may experience epileptic seizures when viewing flashing lights or patterns in our daily environment. These persons may experience seizures while watching TV or playing video games, including DVD videos or games played on the PlayStation®2 console. Players who have not had any seizures may nonetheless have an undetected epileptic condition. Consult your physician before operating the PlayStation®2 console if you have an epileptic condition or experience any of the following symptoms while watching TV programs or playing video games: altered vision, muscle twitching, other involuntary movements, loss of awareness of your surroundings, mental confusion, and/or convulsions.

CLASS 1 LASER PRODUCT
LASER KLASSE 1
LUOKAN 1 LASERLAITE
KLASS 1 LASERAPPARAT

This appliance is classified as a CLASS 1 LASER product.



This label is located on the protective housing of the CD/DVD unit inside the enclosure.

Precautions

Do not expose the console to cigarette smoke or dust

When setting up the console, avoid places subject to excessive cigarette smoke or dust. Cigarette smoke residue or dust build-up on internal components such as the lens, may cause the console to malfunction.

Disc handling

- Do not leave discs near a heat source, in direct sunlight, or in high humidity.
- Store discs in their cases when they are not being used. Stacking discs or standing them at an angle without putting them in their cases can cause the discs to warp.
- Do not touch the disc surface when handling a disc; hold it by the edges.
- Do not stick paper or tape onto the disc.
- Do not write on the disc with a marker, etc.
- Fingerprints, dust, dirt or scratches on the disc can distort the picture or reduce sound quality. Always handle carefully and make sure discs are clean before use.
- Clean discs using a soft cloth, lightly wiping from the centre outwards.
- Do not use solvents such as benzene, commercially available cleaners not intended for CD use or anti-static spray intended for vinyl LPs since these can damage the disc.

Do not touch the console connectors

Do not touch the metal parts or insert foreign objects into the console connectors.

To help protect the expansion bus connector within the EXPANSION BAY, keep the EXPANSION BAY cover in place on the console rear when the bay is not in use.

Do not place the console in an unusually hot location

Do not leave the console in a car with its windows closed (particularly in summer) as this may warp the exterior of the console or cause the console to malfunction.

Moisture condensation

If the console or the disc is brought directly from a cold location to a warm one, moisture may condense on the lens inside the console or on the disc. Should this occur, the console may not operate properly. In this case, remove the disc and do not put the disc back in until the moisture evaporates. (This could take several hours.) If the console still does not operate properly, please contact the appropriate PlayStation® customer service helpline which can be found within every PlayStation® and PlayStation®2 format software manual.

Do not subject the console to violent physical shock

Do not throw or drop the console or its accessories, and do not knock the console or its accessories against other objects. When carrying the console, do not subject it to any type of violent physical shock. This may damage the disc or cause the console to malfunction.

Avoid damaging the exterior of the console

Do not apply any solvents, and do not place any rubber or vinyl materials on the surface of the console for an extended period of time. Doing so may damage the plastic surface or cause the paint to peel off.

Cleaning the exterior of the console

When cleaning the exterior of the console, be sure to turn the power off with the MAIN POWER switch on the back of the console and disconnect the AC power plug from the electrical socket.

- If the exterior of the console becomes dirty, soak a soft cloth in a mild detergent solution diluted with water, tightly squeeze the cloth to remove the excess liquid, wipe the affected area of the exterior and finish by wiping with a dry cloth.
- Do not use benzene or paint thinner to clean the exterior of the console since these may damage the surface or cause the paint to peel off. When using a chemically-treated dust cloth, follow the usage instructions supplied with it.
- Dust can accumulate in both the front and rear vents of the console. Check the vents from time to time and remove any accumulated dust with a handheld or low powered vacuum cleaner.





Never disassemble the console



- Use your PlayStation®2 computer entertainment system according to the instructions in this manual. No authorisation for the analysis or modification of the PlayStation®2 console, nor the analysis and use of its circuit configurations, is given.
- There are no user-serviceable components inside the PlayStation®2 console. Disassembling it will void the guarantee. Additionally, there is a risk of exposure to (laser) radiation as well as to electrical shock hazards.

Notes on safety when using the Analog Controller (DUALSHOCK®2)*

- Stop using the console immediately if you begin to feel tired or if you experience discomfort or pain in your hands or arms while operating the Analog Controller (DUALSHOCK®2). If the condition persists, consult a doctor.
- The Analog Controller (DUALSHOCK®2) is intended for use with the hands only. Do not bring it into close contact with your head, face or the bones of any other part of the body.
- The vibration function of the Analog Controller (DUALSHOCK®2) can aggravate injuries. Do not use the vibration function if you have any ailment or injury to the bones, joints or muscles of your hands or arms. Note that some PlayStation®2 and PlayStation® format software titles set the vibration function to "On" by default. In most cases, the vibration function can be set to "Off" in the options menu of the software. Do not play such titles using the Analog Controller (DUALSHOCK®2) unless you have set the vibration function to "Off".
- Avoid prolonged use of the Analog Controller (DUALSHOCK®2). Take a break at about 30 minute intervals.

* These notes also apply to the Analog Controller (DUALSHOCK®).

	PlayStation®2 format DVD-ROM	PlayStation®2 format CD-ROM	PlayStation® format CD-ROM
Disc logo	“  ”, PlayStation®2 logo and  designation	“  ”, PlayStation®2 logo and  designation	PlayStation® logo and  designation
Disc colour	Silver	Blue	Black
Contents	Audio and video		
Disc size	12 cm		

	Audio CDs		DVD videos* ³		DVD-RW (VR mode)	
Disc logo						
Contents	Audio		Audio and video		Audio and video	
Disc size	12 cm	8 cm* ¹	12 cm	8 cm* ²	12 cm	8 cm* ²



The “DVD VIDEO” and “DVD-RW” logos are trademarks.

*1 When you position the console vertically and play an 8 cm audio CD, use an optional adaptor.

*2 When playing an 8 cm DVD video or DVD-RW disc, always place the console in the horizontal position.

*3 The terms “DVD” and “DVD video” are used to refer to DVD-R, DVD+R and DVD+RW discs as well as DVD-RW discs recorded in Video mode throughout this instruction manual.

DVD video systems and regional restrictions

- This console conforms to the PAL broadcast standard. You cannot play discs recorded for other broadcast standards (such as NTSC) on this console (unless the NTSC disc displays the  label and an NTSC compatible TV is used).
- Some DVD videos are marked with region numbers such as . The number contained within the symbol represents the region number of DVD players on which the disc can be played. DVD videos that do not bear this symbol, or that do not display the number 4 cannot be played on your console.
- DVDs with the  label can also be played on this console.
If you attempt to play any other DVDs, a message stating “This disc cannot be played due to regional restrictions.” will appear on the screen.
- Some DVDs that have no region code markings may still be subject to area restrictions and may not be playable on the console.

Notes on the playback of DVD-R/DVD-RW/DVD+R/DVD+RW discs*

- Some discs recorded using DVD-R/DVD-RW/DVD+R/DVD+RW devices may not be playable due to scratches, dirt, dust, fingerprints or problems encountered during recording, or due to the state of the disc when the recording was made. Only discs that have been finalized (a process that concludes recording) after recording are playable.
- Video recorded on CPRM (Content Protection for Recordable Media) compatible DVD-RW discs using the copy-once capability, will not play that section of video, and the message “Playback is restricted. Cannot play.” will be displayed. For details, refer to the instructions supplied with the DVD recording device. (CPRM is a copy protection system with scramble capability for recorded “copy-once” broadcast programs.)

* For details on each type of DVD media, refer to the Glossary on pages 26-27 of this instruction manual.

Irregularly-shaped discs

Do not use irregularly-shaped CDs or DVDs (for example, heart- or star-shaped discs) as they may cause the console to malfunction.

Note on playback operations of DVDs

This console plays DVD video as originally designed by the software producers. Some of the playback features of this console may not have been incorporated into the DVD video design. As a result, some playback features may not be available with certain DVD videos. Please refer to the instructions supplied with your DVD video for details.

	WARNING	2
	Precautions	2
	Getting started	2
	Discs that can be played on PlayStation®2	3
	Checking the package contents	4
	Positioning the console	4
	Connecting your PlayStation®2 to a TV set	5
	Connecting digital audio equipment	6
	Connecting other digital equipment	7
	Using the main menu	7
	Playing a game	9
	Using Memory Cards	11
	Playing an audio CD	11
	Game / Audio CD	11
	Playing a DVD video	13
	Settings and adjustments for the DVD player	17
	Troubleshooting	24
	Specifications	26
	Glossary	26
	Additional information	26
	GUARANTEE	27

Checking the package contents



Check that you have the following items:

- PlayStation®2 console

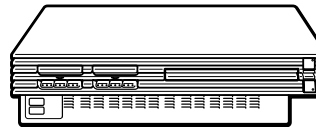

- AC power cord

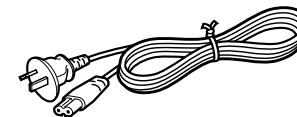

- Analog Controller (DUALSHOCK®2)

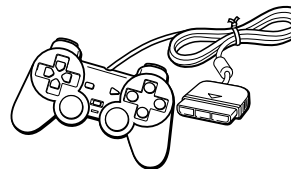

- AV Cable (integrated audio/video)

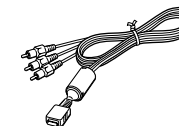

- Instruction manual

If any items are missing, please contact the appropriate PlayStation® customer service helpline which can be found within every PlayStation® and PlayStation®2 format software manual.

Positioning the console

You can position the console either horizontally or vertically.

When positioning the console vertically, use the SCPH-10040 E Vertical Stand (for PlayStation®2) (sold separately).

When positioning the console horizontally, you can use the SCPH-10110 E Horizontal Stand (for PlayStation®2) (sold separately).

Notes

- Do not place the console in a position other than a horizontal or vertical one, as doing so may damage it.
- Do not change the position of the console while it is in operation. Doing so may damage the disc or cause the console to malfunction.

The "PS" product family logo on the disc tray

The "PS" product family logo on the disc tray can be rotated to match the horizontal or vertical positioning of the console.

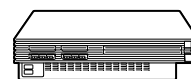

Horizontal positioning

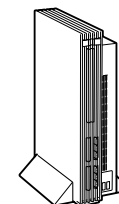

Vertical positioning

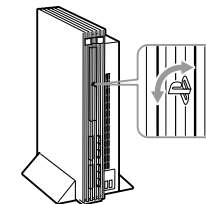

Logo adjustment

You can connect the PlayStation®2 console to most TVs or VCRs using the supplied AV Cable (integrated audio/video) as described below. The console can also be connected to other types of TVs using specialized cables and adaptors, which are sold separately. For details, see the following sections:

- Connecting to a TV with an S VIDEO input connector (this page)
- Connecting to a TV with component video input connectors (page 6)

The instructions in the above sections assume audio output through TV speakers.

Caution

For safety reasons, turn off the console and remove the power plug from the electrical outlet before making or adjusting connections.

Connecting to a TV with audio/video input

Connect your PlayStation®2 console to the TV using the supplied AV Cable (integrated audio/video). When connecting the cords, be sure to match the colour-coded cords to the appropriate jacks on the equipment: yellow (video) to yellow, red (right audio) to red and white (left audio) to white.

After connecting

Set your TV to the appropriate video input mode. Refer to the instruction manual supplied with your TV for details.

When connecting to a wide-screen TV (16:9 aspect ratio)

Set "Screen Size" in the System Configuration menu to "16:9." For details on the System Configuration menu, see pages 7-8.

If your TV is monaural

Do not connect the red plug. If you want to hear both left and right sounds from a monaural TV, use a commercially available dual phono to single phono (stereo to monaural) type audio cable (sold separately).

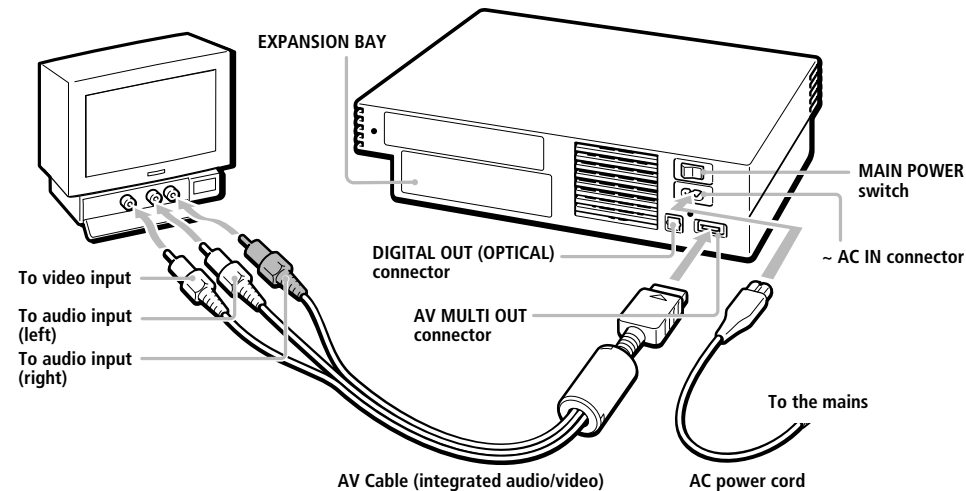

Connecting to a VCR

Connect your PlayStation®2 console to your VCR using the supplied AV Cable (integrated audio/video) matching the plug colours to the jacks on the VCR.

If your VCR is monaural, do not connect the red plug.

However, when playing a DVD video, do not connect the console to a VCR. If you do, picture quality may be reduced. Connect the console directly to the TV.

After connecting

Set your TV and VCR adjustments appropriately. Refer to the instruction manuals supplied with your TV and VCR for details.

When playing a DVD video

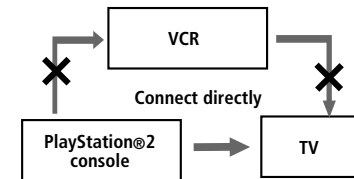

Connecting to a TV with an S VIDEO input connector

Connect your PlayStation®2 console to the S VIDEO input connector on the TV using the SCPH-10060 E S VIDEO Cable (sold separately) for a higher quality picture than that using an AV Cable (integrated audio/video).

After connecting

Set your TV to the appropriate video input mode (such as "S VIDEO").

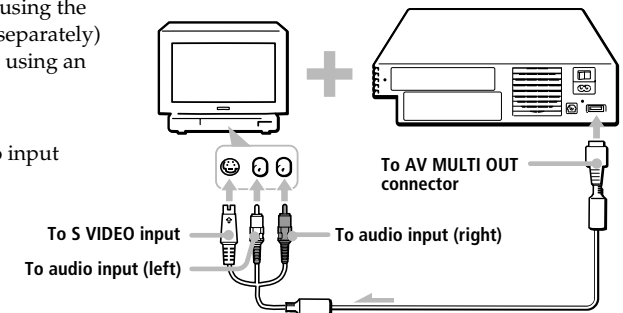

Connecting to a TV with component video input connectors

If your monitor or projector has component video input connectors (Y, CB/PB, CR/PR), connect your PlayStation®2 console using the SCPH-10100 E Component AV Cable (for PlayStation®2) (sold separately). This will provide the best picture.

Before connecting

If you connect your PlayStation®2 console to a television using the Component AV Cable without first setting the "Component Video Out" option under the System Configuration menu to "Y Cb/Pb Cr/Pr," the TV screen might not display properly. Before connecting your console with the Component AV Cable, first use the supplied AV Cable (integrated audio/video) and make sure that the "Component Video Out" option is set to "Y Cb/Pb Cr/Pr."

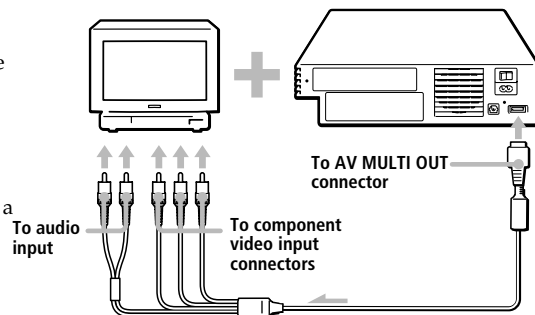

Static image caution

Static, non-moving images, such as DVD menus, configuration displays or paused images may leave a faint image permanently on the TV screen if left on for extended periods of time. Projection TVs, except those of LCD screen types are more susceptible to this than other types of displays. Do not operate the console in such a manner that this could occur.

Note about bouncing effect

Some TVs or monitors may experience a bouncing effect in their pictures when using the PlayStation®2 console. There is nothing wrong with the PlayStation®2 console or the way it is manufactured. The problem technically lies within the television. If you encounter such a problem with your television/monitor, please contact the appropriate PlayStation® customer service helpline which can be found within every PlayStation® and PlayStation®2 format software manual.

This section explains how to connect your PlayStation®2 console to audio equipment with digital connectors (such as Dolby Digital optical (AC-3) output). Using digital receivers and amplifiers, you can enjoy features such as multi-channel sound and surround sound.

Connecting to a receiver or amplifier, "MD (Minidisc)" deck or "DAT (Digital Audio Tape)" deck with a digital connector

Use a commercially available optical digital cable (sold separately) and set "DIGITAL OUT (OPTICAL)" in the System Configuration menu to "On" (the default setting). For details on the System Configuration menu, see pages 7-8.

PlayStation®2 console rear

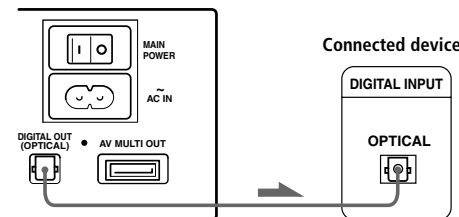

Notes

- Refer also to the instructions supplied with the device to be connected.
- You cannot directly make digital audio recordings of discs recorded in Dolby Digital, DTS or MPEG AUDIO format using an MD or a DAT deck.

Connecting to an audio device with a built-in DTS*1, Dolby Digital*2 or MPEG decoder

By connecting to an audio device with a built-in DTS, Dolby Digital or MPEG decoder (sold separately), you can play back sound recorded in Dolby Digital (AC-3), DTS or MPEG AUDIO format to reproduce the effect of listening in a movie theatre or concert hall.

Connect the device through the DIGITAL OUT (OPTICAL) connector using an optical digital cable (sold separately).

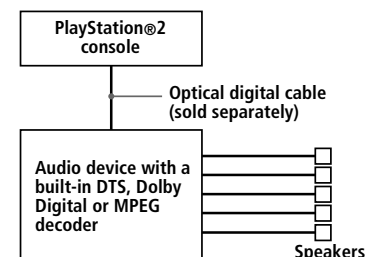

Settings for the DVD player on your PlayStation®2 console

You may need to adjust settings for the DVD player depending on the device to be connected. For details on using the Setup display, see pages 19-23.

- When you connect an audio device with a built-in DTS decoder**
Set "DIGITAL OUT (OPTICAL)" to "On" and then set "DTS" to "On" in the "Audio Setup" display.
- When you connect an audio device with a built-in Dolby Digital decoder**
Set "DIGITAL OUT (OPTICAL)" to "On" and then set "Dolby Digital" to "On" in the "Audio Setup" display.
- When you connect an audio device with a built-in MPEG decoder**
Set "DIGITAL OUT (OPTICAL)" to "On" and then set "MPEG" to "On" in the "Audio Setup" display.

Note

Refer to the operating and setup instructions for the audio device to be connected.

*1 "DTS" and "DTS Digital Out" are trademarks of Digital Theater Systems, Inc.

*2 Manufactured under license from Dolby Laboratories. "Dolby" and the double-D symbol are trademarks of Dolby Laboratories. Confidential unpublished works. © 1992-1997 Dolby Laboratories. All rights reserved.

Connecting a device using the Universal Serial Bus (USB) interface

The two ψ USB connectors on the front of the console can be used to connect USB-compatible devices. Also refer to the instructions supplied with the device to be connected.

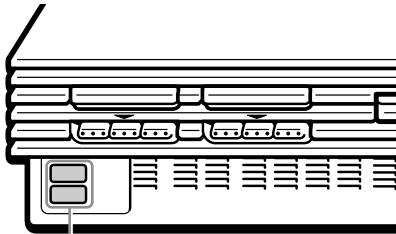

ψ USB connectors

Note

Not all USB-compatible products work with the PlayStation®2 computer entertainment system. See the appropriate USB-compatible product's user manual for more information.

When you turn on the console for the first time you will be prompted to adjust basic language and time settings. These settings can be changed later through the System Configuration menu. For details, see "Using the System Configuration menu" (pages 7-8).

After setup, the main menu is displayed whenever you turn on the console without a disc inserted.

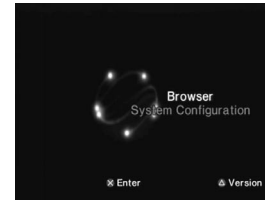

You can move to the Browser screen or the System Configuration menu from the main menu.

Using the Browser screen

You can do the following operations using the Browser screen:

- Check/copy/delete game data on a Memory Card (8MB) (for PlayStation®2) or Memory Card
- Start PlayStation® or PlayStation®2 format software
- Play an audio CD
- Play a DVD video

Select "Browser" using the directional buttons and press the X button.

The Browser screen is displayed. The Memory Card (8MB) (for PlayStation®2), Memory Card or disc inserted in the console are displayed as icons.

Checking/copying/deleting data

You can copy data from one Memory Card (8MB) (for PlayStation®2) or Memory Card to another or delete data you no longer wish to keep.

You cannot, however, copy data of the PlayStation®2 format software to an SCPH-1020 EHI Memory Card.

Insert the Memory Card (8MB) (for PlayStation®2) or Memory Card in advance.

- 1 Select the icon of the Memory Card (8MB) (for PlayStation®2) or Memory Card where the data you want to check/copy/delete is saved, and then press the X button.

- 2 Check/copy/delete data according to the instructions on the screen.

Note

While copying or deleting data, do not remove the Memory Card (8MB) (for PlayStation®2) or Memory Card.

Using the System Configuration menu

Using the System Configuration menu, you can change or update your system settings for your PlayStation®2 console.

Changes to these settings are saved and remain in effect even after you turn off the console. The default settings are underlined.

- 1 Select "System Configuration" using the directional buttons and press the X button.

The System Configuration menu is displayed.

- 2 Select the item you want using the directional buttons and press the X button.

■ Clock Adjustment

Sets the clock.

- 1 Use the directional buttons to set the day and then press the right directional button.

Use the same method to set the month, year, hour, minute and second. To return to the previous menu, press the left directional button.

- 2 Press the X button to start the clock.

Select optional settings for the clock

Select "Clock Adjustment" using the directional buttons and press the Δ button. You can set the following optional items.

Time Format

- 24 hour clock
- 12 hour clock

Date Format

- DD/MM/YYYY
- YYYY/MM/DD
- MM/DD/YYYY

Time Zone

Select the appropriate time zone.

Daylight Savings Time (Summer Time)

Set this item to "Daylight Savings Time (Summer Time)" when the daylight savings time is in effect.

- Standard (Winter Time)
- Daylight Savings (Summer Time)

Screen Size

Selects the display mode according to the TV to be connected.

- 4:3: Select this when you connect a standard TV to the console.
- Full: Select this when you connect a standard TV to the console. The black margins on the upper and lower portions of the screen are cut off.
- 16:9: Select this when you connect a wide-screen TV, or a TV that displays in wide mode to the console.

DIGITAL OUT (OPTICAL)

Selects whether to output signal through the DIGITAL OUT (OPTICAL) connector.

- On: Select this when you connect with an optical digital cable (sold separately). Normally select this option.
- Off: Select this when you do not want sound signal to be output via the DIGITAL OUT (OPTICAL) connector.

Component Video Out

If your TV, monitor or projector has an RGB input connector or component video input connectors (Y, C_B/P_B, C_R/P_R) that conform to the output signals of the console, set this item. When connecting the console using the supplied AV Cable (integrated audio/video) or S VIDEO Cable (sold separately), you do not need to set this item.

- Y Cb/Pb Cr/Pr: Select this when you connect the console to the component video input connectors on your TV.
- RGB: Select this when you connect the console to the RGB input connector on your TV.

Note

You can output PlayStation® and PlayStation®2 format software in either RGB or Y Cb/Pb Cr/Pr format. However, the PlayStation®2 console has been designed to

override the "Component Video Out" setting in the System Configuration menu and output all DVD video software in Y Cb/Pb Cr/Pr. The colour is disturbed when you set this item to "RGB" and play the DVD.

Remote Control

Set this option when using the DVD Remote Control (for PlayStation®2) which is sold separately.

- Gameplay Function On: Select this when operating PlayStation®2 or PlayStation® format software using the DVD Remote Control.
- Gameplay Function Off: Select this when not operating PlayStation®2 or PlayStation® format software using the DVD Remote Control.

Notes

- When Remote Control is set to "Gameplay Function On", some PlayStation®2 or PlayStation® format software may stop operating normally when a controller is removed from controller port 1. Set to "Gameplay Function Off" if this happens.
- Operation using the DVD Remote Control buttons may not work in some cases. Also, the DVD Remote Control will not work when you press two or more buttons at the same time.
- Some unlicensed 3rd party peripherals may not work with "Gameplay Function" set to "On". Note that the use of such peripherals is not recommended and will void your guarantee.

Language

Selects the language for the on-screen display.

- English
- French
- Spanish
- German
- Italian
- Dutch
- Portuguese

Checking version information

You can check version information or settings of various features.

At the main menu, press the Δ button.

The Version Information screen is displayed. The default settings are underlined.

Auto-diagnosis

The PlayStation®2 console automatically adjusts console settings for best possible disc playback. However, you can also manually start the auto-diagnosis feature whenever necessary.

Diagnosis

- Off
- On

1 Select "Console" using the directional buttons and press the Δ button.

2 Select "On" using the directional buttons and press the \times button.

3 Insert a disc.

The console automatically starts the diagnosis.

Note

The diagnosis setting automatically returns to "Off" (default setting) when you press the O /RESET button or start playing a PlayStation® format disc, PlayStation®2 format disc or a DVD video disc.

PlayStation® Driver

The PlayStation® Driver is a programme for loading PlayStation® format software.

Disc Speed

- Standard: Normally select this position.
- Fast: Loading time for a PlayStation® format software disc can be shortened. Depending on the software, there may be no effect or the software may unexpectedly fail. In this case, select "Standard."

Texture Mapping

- Standard: Normally select this position.
- Smooth: You can make the display smoother when playing certain PlayStation® format software titles. Depending on the software, there may be no effect. In this case, select "Standard."

1 Select "PlayStation® Driver" using the directional buttons and press the Δ button.

2 Select the item you want using the directional buttons and press the \times button.

Note

Adjusted settings automatically return to "Standard" (default setting) when you press the O /RESET button or turn off the console.

Clearing the Progressive setting

You can clear the DVD player's Progressive setting.

Clear Progressive Setting

- No
- Yes

1 Use the directional buttons to select "DVD Player", and press the Δ button.

2 Press the \times button.

3 Use the directional buttons to select "Yes" and press the \times button.

The Progressive setting is not cleared immediately after "Yes" is selected. The setting will only be cleared when the DVD video starts playback.

4 Press the O button to return to the main menu. Then use the directional buttons to select "Browser", and press the \times button.

5 Use the directional buttons to select the DVD video icon, and press the \times button.

The DVD player's Progressive setting is cleared, and playback begins.

Notes

- This setting can be cleared only when "Progressive" is set to "On". When "Progressive" is set to "Off", the Options menu under DVD Player is not displayed.
- For details on setting "Progressive" to "On", see "Progressive" under "Settings and adjustments for the DVD player" on page 21.
- The Progressive setting is not cleared if any of the following occur before step 5 is completed:
 - The console enters standby mode after the O (standby)/RESET button has been pressed.
 - The console is turned off using the MAIN POWER switch on the console rear.



Starting a game

- 1 Turn on the console using the MAIN POWER switch on the console rear.**
The \odot (standby) indicator on the console front lights up in red to indicate that the console is now in standby mode.
- 2 Press the \odot (standby)/RESET button.**
The \odot indicator turns green and the start-up screen is displayed.
- 3 Plug the Analog Controller (DUALSHOCK®2) into a controller port of the console.**

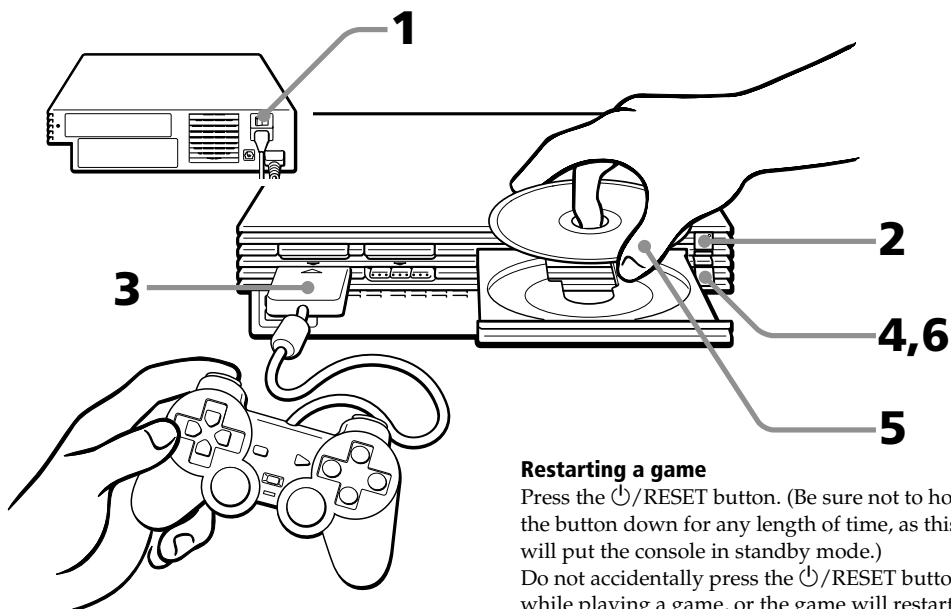

- 4 Press the \triangle (open) button.**
The disc tray opens.
- 5 Place a disc on the disc tray with the label side facing up (data side down).**
- 6 Press the \triangle button.**
The disc tray closes. Screen ② or ③ is displayed and the game is ready to begin.

Note
Set the Analog Controller (DUALSHOCK®2) to the appropriate mode for the software (see "Mode switching and the mode indicator" on page 10). Refer to the appropriate software manual for details.

Restarting a game
Press the \odot /RESET button. (Be sure not to hold the button down for any length of time, as this will put the console in standby mode.) Do not accidentally press the \odot /RESET button while playing a game, or the game will restart.

Screens that appear at start-up

When turning on the console without first inserting a disc

Screen ① is displayed.

- When you insert a PlayStation®2 or PlayStation® format disc after screen ① has appeared, screen ② or ③ is displayed and you can start the game.
- You can move to the Browser screen or the System Configuration menu from screen ①. (For details, see "Using the main menu" on pages 7-8.)

When turning on the console with a disc already inserted

Depending on the type of disc inserted, screen ②, ③ or ④ will be displayed. If screen ④ is displayed, it is possible that the inserted disc is not a PlayStation® or PlayStation®2 format disc. Check the disc type (page 3).

① No disc is inserted (main menu).

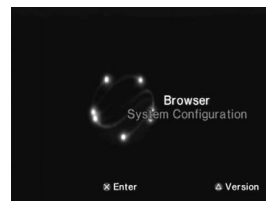

② PlayStation®2 format DVD-ROM / CD-ROM is inserted.



③ PlayStation® format CD-ROM is inserted.



④ A disc that cannot be played with the PlayStation®2 console is inserted.



Ending a game

- 1 Press the \triangle (open) button.**
The disc tray opens.
- 2 Remove the disc.**
- 3 Press the \triangle button.**
The disc tray closes.
- 4 Press and hold down the \odot /RESET button for more than three seconds.**
The \odot indicator turns red and the console enters standby mode.

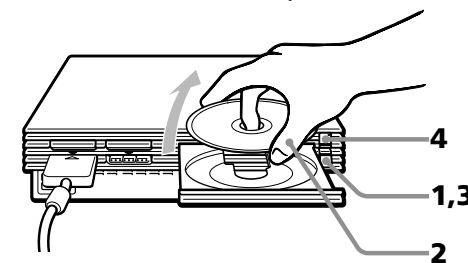





When not intending to play a game for an extended period of time

Turn the power off at the MAIN POWER switch on the console rear, and disconnect the power plug from the electrical socket.

Changing from one game to another

There is no need to turn off the console when you want to change games.

- 1 Press the  (open) button.**
The disc tray opens.
- 2 Remove the disc.**
- 3 Place a new disc in the disc tray.**
- 4 Press the  button.**
The disc tray closes.
- 5 Press the /RESET button to reset.**
(**Note:** holding the /RESET button down for any length of time may cause the console to go into standby mode.)
After the start-up screen, screen **②** or **③** is displayed and the game begins.

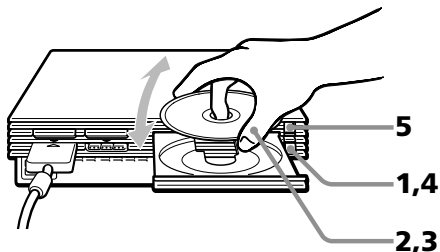

Note

With a multi-disc game, follow steps 1 through 4 to switch discs. Refer to the software manual for details.

Using the Analog Controller (DUALSHOCK®2)

- The Analog Controller (DUALSHOCK®2) can be used with PlayStation®2 and PlayStation® format software.
- You can switch between digital and analog modes. When the controller is in analog mode, the following buttons and sticks may operate in analog fashion depending on the features supported by the software title. Refer to the software manual for details.

PlayStation®2 format software

Directional buttons, Δ , \circ , \times , \square buttons, left analog stick, right analog stick, L1, R1, L2, R2 buttons

PlayStation® format software

Left analog stick / right analog stick

- You can use the vibration function.

Using an Analog Controller (DUALSHOCK®) (sold separately)

- The Analog Controller (DUALSHOCK®) can also be used with PlayStation®2 and PlayStation® format software.
- You can switch between digital and analog modes. When in analog mode, you can enjoy the analog operation of the left analog stick and right analog stick.

PlayStation®2 format software

Left analog stick / right analog stick

PlayStation® format software

Left analog stick / right analog stick

- You can use the vibration function.

Mode switching and the mode indicator

The Analog Controller (DUALSHOCK®2) can be switched between digital mode and analog mode by pressing the ANALOG mode button. Each time the ANALOG mode button is pressed, the mode changes as follows:

Digital mode (indicator: off)



Analog mode (indicator: red)

Note

Switch to the appropriate mode for use.

Note however, that some software will make this adjustment automatically. In such cases, the ANALOG mode button is overridden by the software. For details, refer to the software manual.

Vibration function

The Analog Controller (DUALSHOCK®2) features a vibration function when the function is supported by the software title. The vibration function can be set to ON or OFF on the software option screen.

Notes

- When the Analog Controller (DUALSHOCK®2) is not being used, turn the console off or unplug the controller from the console.
- Before using the vibration function, please read "Notes on safety when using the Analog Controller (DUALSHOCK®2)" on page 2.

Before using the Analog Controller (DUALSHOCK®2)

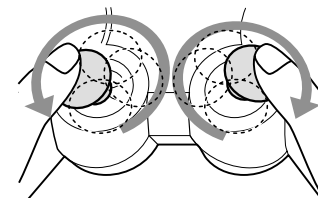

After turning the console on, rotate the analog sticks once with your thumbs before starting a game. Do not twist the analog sticks but rotate as if drawing a circle as shown in the diagram above.

Digital mode (indicator: off)

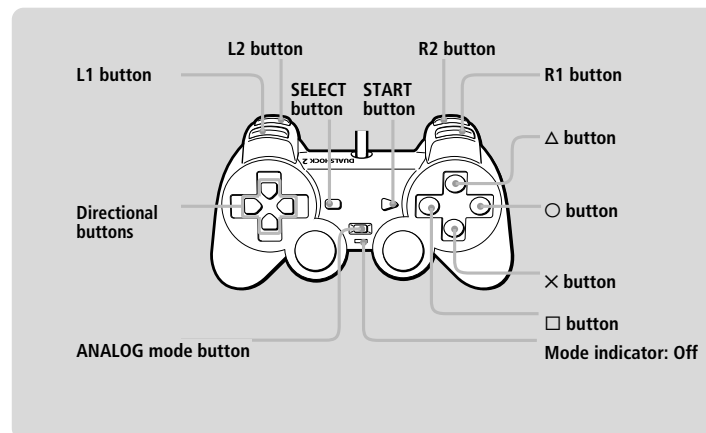

Analog mode (indicator: red)

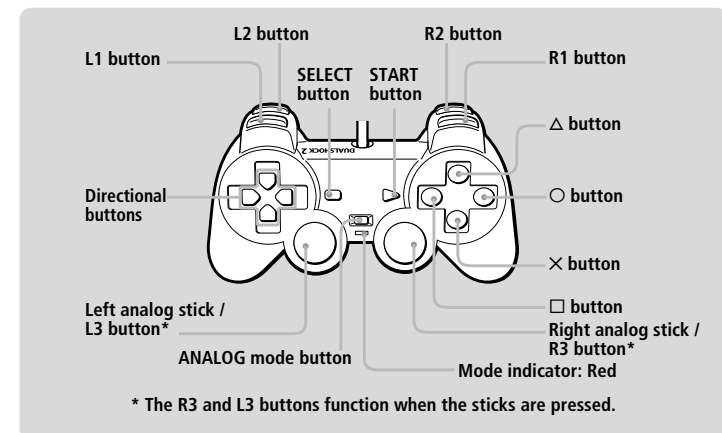

You can save and load game or other data using the Memory Card (8MB) (for PlayStation®2) or Memory Card (each sold separately).

Differences between the Memory Card (8MB) (for PlayStation®2) and Memory Card

When playing PlayStation®2 format software, use the Memory Card (8MB*) (for PlayStation®2) (①).
When playing PlayStation® format software, use the Memory Card (②).

*8 MB = 8,000 KB

For the PlayStation® video game console, units of game data are described as “memory blocks,” however for the PlayStation®2 computer entertainment system, they are described as “KB” (kilobytes).

① Memory Card (8MB) (for PlayStation®2) (sold separately)

The Memory Card (8MB) (for PlayStation®2) can save and load PlayStation®2 format software game data. Each Memory Card (8MB) (for PlayStation®2) can save about 8 MB of game data, but some of this may be used as file control information. The Memory Card (8MB) (for PlayStation®2) uses **MAGICGATE**, a technology that helps protect copyrighted content through data encryption and hardware authentication.

MAGICGATE is a term of copyright protection technology developed by Sony Group. **MAGICGATE** does not guarantee compatibility with other products bearing the “MagicGate” trademark.

② Memory Card (sold separately)

The Memory Card can save and load PlayStation® format software game data. Each Memory Card can save 120 KB (15 memory blocks) of game data.

Note

You cannot copy data to a Memory Card (8MB) (for PlayStation®2) or Memory Card that does not have enough memory available. Before playing, check how much space is needed to save the game and how much space is available on the Memory Card (8MB) (for PlayStation®2) or Memory Card. Check the appropriate software manual to determine the amount of space needed to save the data for a given game.

Inserting Memory Card (8MB) (for PlayStation®2) or Memory Card

Insert the Memory Card (8MB) (for PlayStation®2) or Memory Card into the MEMORY CARD slot, with the arrow side up.

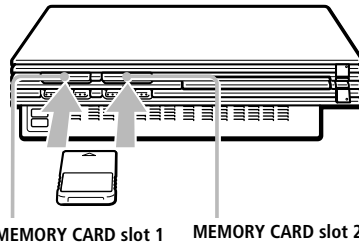

Notes on using the Memory Card (8MB) (for PlayStation®2) or Memory Card with a Multitap

- When using PlayStation®2 format software, use the SCPH-10090 E Multitap (for PlayStation®2).
- When using PlayStation® format software, use the SCPH-1070 E Multitap.
- When you insert the SCPH-1070 E Multitap into controller port 1, do not insert the Memory Card (8MB) (for PlayStation®2) or Memory Card into MEMORY CARD slot 1 of the PlayStation®2 console. This also applies when you insert the Multitap into controller port 2. If you do so, the data may be lost.

Checking/copying/deleting game data

You can copy game data from one Memory Card (8MB) (for PlayStation®2) or Memory Card to another or delete data you no longer wish to keep. You cannot, however, copy game data of PlayStation®2 format software to the Memory Card.

You can check, copy and delete game data in the Browser screen. For details on the browser, see “Checking/copying/deleting data” on page 7.

Note

You cannot save or load game data in the Browser screen. For details on game data saving or loading, refer to the software manual.

Playing an audio CD

- 1 Press the \triangle (open) button.
The disc tray opens.
- 2 Place a disc on the disc tray with the label side facing up (data side down).
- 3 Press the \triangle button.
The disc tray closes.
- 4 Use the directional buttons to select the audio CD icon, and press the \times button.
The audio CD screen is displayed.
- 5 Select the track number you want to play and press the \times button.
Playback begins.

Ending audio CD playback

- 1 Press the \triangle (open) button.
The disc tray opens.
- 2 Remove the disc.
- 3 Press the \triangle button.
The disc tray closes.
- 4 Press and hold down the O /RESET button for more than three seconds.
The console enters standby mode.

Operating the CD player

The CD player can be operated using the Control Panel or directly with the buttons on the Analog Controller (DUALSHOCK®2). You can also operate the CD player using the SCPH-10420 E DVD Remote Control (for PlayStation®2), which is sold separately. During playback, select the icon in the CD operation screen using the directional buttons and then press the \times button.

- \blacktriangleright Start playback
- II Pause
- \blacksquare Stop playback
- $\blacktriangleleft\blacktriangleleft$ Find the beginning of the current or previous track
- $\blacktriangleright\blacktriangleright$ Find the beginning of the next track
- \blacktriangleleft Fast reverse
- \blacktriangleright Fast forward

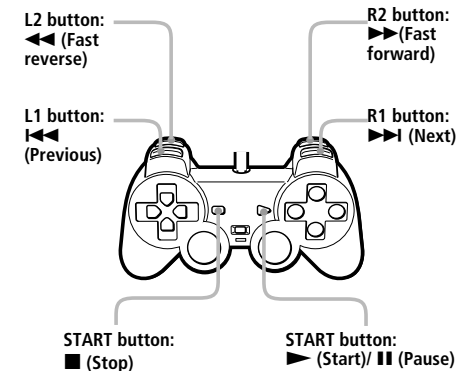

Music discs encoded with copyright protection technologies

The audio CD playback feature of this product is designed to conform to the Compact Disc (CD) standard. Recently, some record companies have started marketing music discs encoded with copyright protection technologies. Some of these music discs do not conform to the CD standard, and may not be playable on this product.

Playing in various modes

You can change between various play modes. The default setting for “Play Mode” is “Normal”, and the default for “Repeat” is “Off”.

Select the audio CD icon in the Browser screen, and then press the Δ button to change the settings.

To play the desired tracks in a specified order

- 1 Select “Play Mode” using the directional buttons and press the \times button.
- 2 Select “Program” using the directional buttons and press the \times button.
- 3 Select the number of the specific track using the directional buttons, and press the \times button. Repeat this step to select all the tracks you want to play.
- 4 Press the \circ button to return to the Browser screen.
- 5 Select the audio CD icon, and press the \times button.

The tracks are displayed in their programmed order. Select the track number you want to play, and press the \times button. Playback begins.

To play the desired tracks repeatedly

Follow steps 1 to 4, and then follow the instructions on playing all tracks repeatedly, or on playing one track repeatedly. For details, see “To play all tracks repeatedly” or “To play a track repeatedly” at right.

To play the tracks in random order

- 1 Select “Play Mode” using the directional buttons and press the \times button.
- 2 Select “Shuffle” using the directional buttons and press the \times button.
- 3 Press the \circ button to return to the Browser screen.
- 4 Select the audio CD icon, and press the \times button.
The tracks are displayed in random order. Select the track number you want to play, and press the \times button. Playback begins.

To play random tracks repeatedly

Follow steps 1 to 3, and then follow the instructions on playing all tracks repeatedly, or on playing one track repeatedly. For details, see “To play all tracks repeatedly” or “To play a track repeatedly” at right.

To play all tracks repeatedly

- 1 Select “Repeat” using the directional buttons and press the \times button.
- 2 Select “All” using the directional buttons and press the \times button.
- 3 Press the \circ button to return to the Browser screen.
- 4 Select the audio CD icon, and press the \times button.
The tracks are displayed. Select the track number you want to play, and press the \times button. Playback begins.

To play desired or random tracks repeatedly

Follow steps 1 to 3, then follow the instructions on playing the desired tracks in a specified or tracks in random order. For details, see “To play the desired tracks in a specified order” or “To play the tracks in random order” at left.

To play a track repeatedly

- 1 Select “Repeat” using the directional buttons and press the \times button.
- 2 Select “1” using the directional buttons and press the \times button.
- 3 Press the \circ button to return to the Browser screen.
- 4 Select the audio CD icon, and press the \times button.
The tracks are displayed. Select the track number you want to play, and press the \times button. Playback begins.

To play a track in Program Play or Shuffle Play repeatedly

Follow steps 1 to 3, then follow the instructions on playing the desired tracks in a specified order or tracks in random order. For details, see “To play the desired tracks in a specified order” or “To play the tracks in random order” at left.

You can go to the Play Options screen from the screen displaying the track numbers.

Select the small audio CD icon on the top left of the screen using the up or left directional button, and press the Δ button. The Play Options screen is displayed, and you can operate the CD player in the same manner as in “Playing in various modes” at left. Press the \circ button in the Play Options screen and the tracks are displayed. Choose the track you want to play, and press the \times button. Playback begins.

Notes on playing an audio CD with a DTS audio track

- If you play an audio CD recorded in DTS format, an extremely loud noise will be emitted from the analog audio output of an audio device connected to the AV MULTI OUT connector. Be careful not to cause damage to your audio system when the audio device's analog audio output is connected to the receiver (amplifier). You must connect a DTS decoder to the DIGITAL OUT (OPTICAL) connector to playback DTS audio tracks.
- When DIGITAL OUT (OPTICAL) is set to “Off” in the System Configuration menu, you will not be able to hear the DTS audio from an audio CD even if the audio device is connected using an optical digital cable.



Playing a DVD video

Depending on the DVD video, some operations may be different or restricted. Refer to the instructions supplied with your disc for details.

1 Turn on the console using the MAIN POWER switch on the console rear.

The (standby) indicator on the console front lights up in red to indicate that the console is now in standby mode.

2 Press the (standby)/RESET button.

The indicator turns green and the start-up screen is displayed.

3 Press the button.

The disc tray opens.

4 Place a disc on the disc tray with the label side facing up (data side down).

5 Press the button.

The disc tray closes and DVD content is displayed on the screen.

Notes

- If you press the button during or after playback, the Browser screen appears.
- When playing a DVD video, do not connect the console to a VCR. If you do, picture quality may be reduced. Connect the console directly to the TV.

Ending DVD video playback

When you have finished viewing a DVD, follow the steps below to save DVD player settings, return to the Browser screen or put the console in standby mode.

1 Press the (open) button.

The disc tray opens and the Browser screen is displayed.

2 Remove the disc.

3 Press the button to close the disc tray.

4 Press and hold down the /RESET button for more than three seconds.

The indicator turns red and the console enters standby mode.

Note

To save changes to DVD player settings you must eject the DVD before pressing the (standby)/RESET button or turning off the console using the MAIN POWER switch on the console rear.

Operating the DVD player

There are three ways to operate the DVD player:

- You can operate the DVD player directly using the Analog Controller (DUALSHOCK®2) as explained below.
- You can operate the DVD player through the on-screen Control Panel. The Control Panel allows access to additional DVD player options and settings. For details, see "Using the Control Panel" on page 14.

- You can also operate the DVD player using the DVD Remote Control (for PlayStation®2) which is sold separately.

Using the Analog Controller (DUALSHOCK®2)

The function of each button on the Analog Controller (DUALSHOCK®2) is explained below.

Note

The direct button functions of the Analog Controller (DUALSHOCK®2) cannot be used when the Control Panel is displayed.

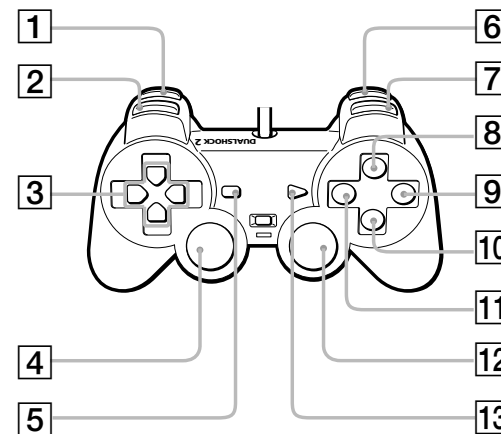

1 L2 button (Fast Reverse Search)

Fast reverses playback on the screen to aid in looking for a particular scene.

2 L1 button (Previous)

Returns to the beginning of the current or previous chapter.

3 Up, down, left, and right directional buttons

Used to select items displayed on the screen.

4 L3 button (Subtitle Options)*

Displays and changes DVD subtitle options.

5 SELECT button

Displays the Control Panel.

6 R2 button (Fast Forward Search)

Fast forwards playback on the screen to aid in looking for a particular scene.

7 R1 button (Next)

Skips to the beginning of the next chapter.

8 button (Menu)

Displays the disc menu of DVD-Video discs. The content of the menu varies from disc to disc.

9 button (Stop)

Stops playback.

10 button (Enter)

Enters the item selected on the screen.

11 button (Top Menu)

Displays the disc menu of DVD-Video discs. The content of the menu varies from disc to disc.

12 button (Audio Options)*

Displays and changes DVD audio options.

13 button (Play/II Pause)

Starts playback/Pauses and resumes playback.

* When using a controller without the L3 or R3 buttons, use the Control Panel to select among available subtitle and audio options.

Using the Control Panel

You can select various playback modes and adjust DVD player settings using the on-screen Control Panel.

Navigate the Control Panel using the Analog Controller (DUALSHOCK®2) as described below.

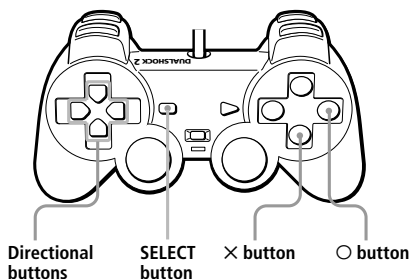

Display or turn off the Control Panel	SELECT button
Enter	X button
Cancel	O button
Select	Up, down, left, and right directional buttons

1 Press the SELECT button.

The Control Panel is displayed.

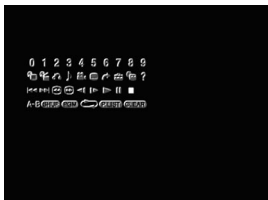

2 Select the item you want using the directional buttons.

3 Press the X button.

For details on each Control Panel display item, see pages 14–23.

Control Panel item list





- | | | |
|--|--|---|
| <p>1 Menu (page 15)
Displays the disc menu of DVD-Video discs. The content of the menu varies from disc to disc.</p> <p>2 Top Menu (page 15)
Displays the disc menu of DVD-Video discs. The content of the menu varies from disc to disc.</p> <p>3 Return (page 15)
Returns to the previously selected screen.</p> <p>4 Audio Options (page 17)
Displays and changes DVD audio options.</p> <p>5 Angle Options (page 17)
Displays and changes DVD viewing angle options.</p> <p>6 Subtitle Options (page 17)
Displays and changes DVD subtitle options.</p> <p>7 Go To (page 18)
Skips to the selected title or chapter number or the specified time, and starts playback.</p> <p>8 Setup (page 19)
Displays the Setup display for changing various picture and audio options. You can also choose a language for subtitles and the menu, set Parental Control level, and so on.</p> | <p>9 Time Display (page 18)
Displays the current title or chapter number, and the elapsed or remaining time.</p> <p>10 Help (page 18)
Displays the direct button functions of the Analog Controller (DUALSHOCK®2).</p> <p>11 Go to Chapter (page 18) / Number icons
Used to enter the number of a chapter you wish to play, or numerical codes.</p> <p>12 Previous
Returns to the beginning of the current or previous chapter.</p> <p>13 Next
Skips to the beginning of the next chapter.</p> <p>14 Search (page 18)
Fast reverses playback on the screen to aid in looking for a particular scene.</p> <p>15 Search (page 18)
Fast forwards playback on the screen to aid in looking for a particular scene.</p> <p>16 Slow (page 18)
Changes to reverse playback in slow-motion.</p> <p>17 Slow (page 18)
Changes to playback in slow-motion.</p> | <p>18 Play
Starts playback.</p> <p>19 Pause
Pauses and resumes playback.</p> <p>20 Stop
Stops playback.</p> <p>21 A-B A-B Repeat (page 16)
Specifies a scene for playback, and starts playback of the scene that has been set.</p> <p>22 SHUF Shuffle Play (page 16)
Starts playback of titles or chapters in random order.</p> <p>23 PGM Program Play (page 15)
Displays the Program Setup screen.</p> <p>24 Repeat Play (page 16)
Selects repeated playback of all the titles on the disc, or one title or chapter.</p> <p>25 PLIST Original/Play List (page 17)
For DVD-RW discs recorded in VR mode. Selects Original or Play List content to play back.</p> <p>26 CLEAR Clear
Clears selected numbers or playback modes.</p> |
|--|--|---|

You can use the Control Panel to set various playback modes.

Using the DVD disc menu

Some DVDs allow you to select disc contents from a menu. When you play such DVDs, you can select the language for the subtitles, the language for the sound, and other options using the menu.

- 1 Use the directional buttons to select the  (Menu) or  (Top Menu) icon, and press the X button.

The menu is displayed. Menu content may vary depending on the DVD.

- 2 Use the directional buttons to select an item, and press the X button.

To return to the previous screen in the menu

Use the directional buttons to select the  (Return) icon, and press the X button. This function may not be available on some DVDs.

Using the Analog Controller (DUALSHOCK®2)

- 1 Press the  or  button.

The menu is displayed. Menu content may vary depending on the DVD.

- 2 Use the directional buttons to select an item, and press the X button.

Notes

- Some DVDs do not have a menu.
- Depending on the DVD, a menu may be referred to as "DVD Menu", "Title Menu" or "Titles" in the instructions supplied with the disc.

To check playback settings

When playing a disc use the directional buttons to select the  (Time Display) icon, and press the X button. Icons for currently set playback modes will be displayed in the top right corner of the screen.

To clear all playback settings and return to normal playback

Use the directional buttons to select **CLEAR**, and press the X button.

Playback from the last stopping point (Resume Play)

The DVD player remembers the point where you stopped the disc, and resumes playback from that point.

- 1 During playback, press the  button to stop playback.

The message, "Press [Play] to resume viewing. To start from the beginning, press [Stop] and then [Play]." appears, and then the Control Panel (page 14) is displayed on the TV screen.

If the message "Resume function cannot be used here. Play will restart from the beginning." appears, Resume Play is not available.

- 2 Select the  (Play) icon using the directional buttons and press the X button.

The DVD player starts playback from the point where you stopped the disc in step 1.

To clear the last stopping point



After step 1, select the  (Stop) icon and press the X button

To clear Resume Play

If you resume playback after stopping, the DVD player enters Resume Play mode. Many advanced settings for the DVD player are not available during Resume Play. If you want to clear Resume Play to adjust settings, select the  (Stop) icon and press the X button twice.

Notes

- Resume Play may not be available on some DVDs or some video scenes.
- Depending on where you stop playback, the console may resume playback from a slightly different point.

- Resume Play is not available when:
 - Program Play or Shuffle Play is selected.
 - The disc tray on the console front is opened using the  button.
 - The console is reset or goes into standby mode after the /RESET button has been pressed.
 - The power is turned off using the MAIN POWER switch on the console rear.
 - The  (Stop) icon is selected and the X button is pressed twice during playback.

Playback in desired order (Program Play)

You can create a program to play back titles and chapters in any order you like.

- 1 Use the directional buttons to select the  (Program Play) icon, and press the X button.
- 2 Use the directional buttons to select the item number, and press the X button.
- 3 Use the directional buttons to select the title number, and press the X button.
- 4 Use the directional buttons to select the chapter number, and press the X button.
- 5 Repeat steps 2 - 4 to set other titles or chapters.
- 6 Press the START button.
Program Play begins.

Program Play settings are saved and remain in effect even after playback ends. Use the directional buttons to select the  (Program Play) icon, and then press the X button. The Program Setup screen is displayed. Press the START button to play the programmed sequence again.

Changing or clearing Program Play settings



- 1 Use the directional buttons to select the  (Program Play) icon, and press the X button.
- 2 Use the directional buttons to select the item number you want to change, and press the X button.
- 3 Use the directional buttons to select the title number you want to play, and press the X button.
- 4 Use the directional buttons to select the chapter number you want to play, and press the X button.

To clear Program Play settings, select "Clear" at step 3, and press the X button.

To clear all Program Play settings

- 1 Use the directional buttons to select the  (Program Play) icon, and press the X button.
- 2 Use the directional buttons to select "Clear all", and press the X button.

To use Program Play with Shuffle Play or Repeat Play

- Program Play with Shuffle Play
During playback in Program Play mode, use the directional buttons to select the  (Shuffle Play) icon, and press the X button. Shuffle Play is turned on. When Shuffle Play is used with Program Play, Shuffle Play options are limited to "Shuffle On" and "Shuffle Off".
- Program Play with Repeat Play
During playback in Program Play mode, use the directional buttons to select the 

(Repeat) icon, and press the X button.

Repeat Play is turned on.

When Repeat Play is used with Program Play, Repeat Play options are limited to "Repeat On" and "Repeat Off".

For details on Shuffle Play and Repeat Play, see "Playback in random order (Shuffle Play)" below, and "Repeated Playback (Repeat Play)" at right.

Notes

- Program Play settings cannot be changed while playing in Program Play mode.
- A-B Repeat is cleared when Program Play is set.
- Program Play may not be available on some discs.
- Only the number of titles and chapters recorded in the disc will be displayed on the screen.
- Program Play is stopped when:
 - A-B Repeat is set.
 - The DVD disc menu is displayed.
- Program Play settings are cleared when:
 - The disc tray is opened using the button on the console front.
 - The console is reset or goes into standby mode after the /RESET button has been pressed.
 - The power is turned off using the MAIN POWER switch on the console rear.

Playback in random order (Shuffle Play)

The console will automatically select a random order to play titles and chapters. Playback order will be different each time Shuffle Play is used.

During playback, use the directional buttons to select the (Shuffle Play) icon, and press the X button.

The screen will display the following shuffle modes in turn each time the X button is pressed. Shuffle Play will begin as soon as the playback mode is selected.

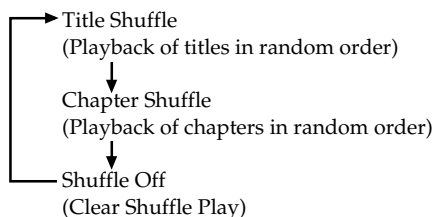

To end Shuffle Play

Use the directional buttons to select the (Shuffle Play) icon, and press the X button until "Shuffle Off" is displayed.

To use Shuffle Play with Program Play or Repeat Play

- Shuffle Play with Program Play

During playback in Shuffle Play mode, use the directional buttons to select the (Program Play) icon, and press the X button to select program settings. Press the START button. Shuffle Play is turned on.

When Program Play is used with Shuffle Play, Shuffle Play options are limited to "Shuffle On" and "Shuffle Off".
- Shuffle Play with Repeat Play

During playback in Shuffle Play mode, use the directional buttons to select the (Repeat) icon, and press the X button. Repeat Play is turned on.

When Repeat Play is used with Shuffle Play, Repeat Play options are limited to "Repeat On" and "Repeat Off".

For details on Program Play and Repeat Play, see "Playback in desired order (Program Play)" on page 15, or "Repeated Playback (Repeat Play)" at right.

To set Shuffle Play when a disc is not playing

Use the directional buttons to select the (Shuffle Play) icon, and press the X button until the shuffle mode you want to set is displayed. Use the directional buttons to select the (Play) icon, and press the X button. Shuffle Play begins.

Notes

- A-B Repeat is cleared when Shuffle Play is set.
- Shuffle may not be available on some discs.
- Shuffle Play is cleared when:
 - A-B Repeat Play is set.
 - The DVD disc menu is displayed.
 - The disc tray is opened using the button on the console front.
 - The console is reset or goes into standby mode after the /RESET button has been pressed.
 - The power is turned off using the MAIN POWER switch on the console rear.
- When Chapter Shuffle is selected, up to 200 chapters can be played in random order. If the disc has more than 200 chapters, 200 chapters will be selected at random.

Repeated Playback (Repeat Play)

All of the titles on the DVD, or one title or chapter can be repeatedly played back using Repeat Play.

During playback, press the directional buttons to select the (Repeat) icon, and press the X button.

The screen will display the following repeat modes in turn each time the X button is pressed. Repeat Play will begin as soon as the repeat playback mode is selected.

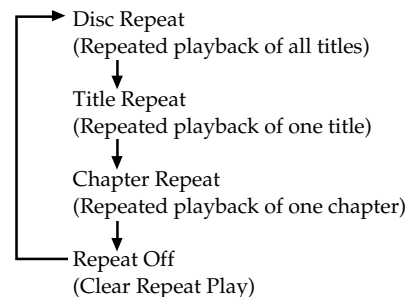

To end Repeat Play

Use the directional buttons to select the (Repeat) icon, and press the X button until "Repeat Off" is displayed.

To use Repeat Play with Program Play or Shuffle Play

- Repeat Play with Program Play

During playback in Repeat Play mode, use the directional buttons to select the (Program Play) icon, and press the X button. Make program selections and press the START button. Repeat Play is turned on. When Program Play is used with Repeat Play, Repeat Play options are limited to "Repeat On" and "Repeat Off".
- Repeat Play with Shuffle Play

During playback in Repeat Play mode, use the directional buttons to select the (Shuffle Play) icon, and press the X button. Repeat Play is turned on. When Shuffle Play is used with Repeat Play, Repeat Play options are limited to "Repeat On" and "Repeat Off".

For details on Program Play and Shuffle Play, see "Playback in desired order (Program Play)" on page 15, or "Playback in random order (Shuffle Play)" at left.

To set Repeat Play when a disc is not playing

Use the directional buttons to select the (Repeat) icon, and press the X button until the repeat mode you want is displayed. Use the directional buttons to select the (Play) icon, and press the X button. Repeat Play begins.

Notes

- A-B Repeat is cleared when Repeat Play is set.
- Repeat Play may not be available on some discs.
- Repeat Play is cleared when:
 - A-B Repeat is set.
 - The disc tray is opened using the button on the console front.
 - The console is reset or goes into standby mode after the /RESET button has been pressed.
 - The power is turned off using the MAIN POWER switch on the console rear.

Repeated playback of a selected scene (A-B Repeat)

You can set a specific section of the disc to be repeatedly played back.

- 1 During playback, use the directional buttons to select the A-B (A-B Repeat) icon, and press the X button at the point you want to start repeated playback.



The starting point A is set.

- 2 Use the directional buttons to select the A-B (A-B Repeat) icon, and press the X button at the point you want to end repeated playback.

The ending point B is set, and repeated playback of the section from A to B begins.

Notes

- A-B Repeat may not be available on some discs or some sections of a disc.

- The A-B Repeat function can be set for only one section at a time.
- A-B Repeat cannot be set to select a section of video that includes content from more than one title.
- A-B Repeat is cleared when:
 - Program Play, Shuffle Play, or Repeat Play has been set.
 - Playback has been stopped.
 - The DVD disc menu is displayed.
 - The disc tray is opened using the  button on the console front.
 - The console is reset or goes into standby mode after the /RESET button has been pressed.
 - The power is turned off using the MAIN POWER switch on the console rear.
- When A-B Repeat is set, Program Play, Shuffle Play, and Repeat Play is cleared.

Selecting Original/Play List for DVD-RW playback



DVD-RW discs (VR mode) can play back both original content recorded using a DVD recorder, and Play List content created by editing original content. By using this kind of disc you can select the type of title you want to play. This setting is not available during Resume Play.

Stop playback, and use the directional buttons to select the  (Original/Play List) icon. Then press the X button.

Original and Play List will be selected in turn each time you press the X button.

- Original: Playback of originally recorded content.
- Play List: Playback of edited content.

Notes

- The default setting for this option is Play List.
- Note that you cannot record or edit content using this console.
- If a disc has no Play List, the original content will be played back. Play List cannot be selected.
- A-B Repeat cannot be set to select a section of video that includes content from more than one title.
- Slow-motion play (in reverse) is not available for DVD-RW discs (VR mode).
- The “Original” setting will be cleared when:
 - The disc tray is opened using the  button on the console front.
 - The console is reset or goes into standby mode after the /RESET button has been pressed.
 - The power is turned off using the MAIN POWER switch on the console rear.
- Content recorded on DVD-RW discs in VR mode must be finalized to be viewed on the PlayStation®2 console.

You can use the Control Panel to navigate the DVD and adjust DVD player settings.

Changing the audio language

Some DVDs are recorded with audio tracks for multiple languages (multilingual tracks). When you play such DVDs you can select the language you want to hear during playback. The languages available to select from may vary depending on the DVD.

Use the directional buttons to select the  (Audio Options) icon, and press the X button. The language changes each time you press the X button.

Using the Analog Controller (DUALSHOCK®2)

Press the R3 button.

The language changes each time you press the R3 button.

Notes

- Due to the programming on some DVDs, you may not be able to change languages even if multilingual tracks are recorded on the DVD.
- When playing a DVD, the audio settings may change when you change titles.
- When you the “DTS” option of “Audio Digital Out” to “Off” under “Audio Setup” in the Setup display, you cannot play DTS audio tracks even if such tracks are recorded on the DVD.

Changing the viewing angle

With DVDs on which multiple angles (multi-angles) are recorded, you can change the viewing angle on scenes for which multiple angles are available. For example, while playing the scene of a train in motion, you can change the view from the front of the train, the left window, or the right window, without interrupting the movement of the train.

Use the directional buttons to select the  (Angle Options) icon, and press the X button. The angle changes each time you press the X button.

Notes

- The number of angles varies depending on the disc and the scene. For any given scene you can choose from among the angles recorded for that scene.

- Due to the programming on some DVDs, you may not be able to change angles even if multiple angles are recorded on the DVD.

Displaying subtitles

If subtitles are recorded on a DVD, you can turn the subtitles on and off during playback. When multilingual subtitles are available, you can also change the subtitle language.

Use the directional buttons to select the  (Subtitle Options) icon, and press the X button. The subtitle language changes each time you press the X button. The subtitle languages available to select from will vary depending on the DVD.

To turn the subtitles off

Use the directional buttons to select the  icon, and press the X button until “Subtitles Off” is displayed.

Using the Analog Controller (DUALSHOCK®2)

Press the L3 button.

The subtitle language changes each time you press the L3 button. The subtitle languages you can select will vary depending on the DVD.

To turn the subtitle language off

Press the L3 button until “Subtitles Off” is displayed.

Notes

- When playing a DVD on which no subtitles are recorded, no subtitles can be displayed.
- Due to the programming on some DVDs, you may not be able to display subtitles or switch among subtitle languages even if subtitles are recorded on the DVD.
- Depending on the DVD, you may not be able to turn the subtitles off.
- The type and number of languages for subtitles varies from disc to disc.
- While playing a DVD, the subtitle setting may change when you change titles.

Selecting a specific scene for playback

You can select a specific scene for playback by specifying the title or chapter number, or by entering the elapsed time for the starting point of the scene that you want to play.

Selecting a scene by chapter number

During playback, use the directional buttons to select the desired chapter number, and press the X button.

Playback of the selected chapter begins.

Selecting a scene by title number, chapter number, or by specifying the time.

1 During playback, use the directional buttons to select the  (Go To) icon, and press the X button.

2 Use the directional buttons to select an item, and press the X button.

- Title= Title number
- Chapter=Chapter number
- C XX:XX:XX (or T XX:XX:XX)=Elapsed time for the chapter (or title)

3 Use the directional buttons to select the playback point, and press the X button.

Playback of the selected scene begins.

Note

You cannot select a scene by specifying the remaining time of the chapter or title (only elapsed time can be used).

Displaying playback information

You can display information such as the current title or chapter number, or the elapsed or remaining time on a disc. When Program Play or Shuffle Play modes are set, this information will also be displayed in the top right corner of the screen.

During playback or when the disc is paused, use the directional buttons to select the  (Time Display) icon, and press the X button. The display changes as shown below, each time you press the X button.

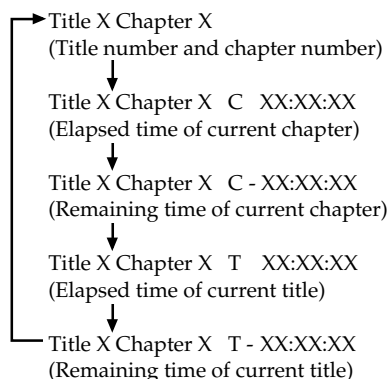

Note

You cannot display the remaining time for some titles.



Displaying the list of direct button functions (Help)

You can display a list that shows the function of each button on the Analog Controller (DUALSHOCK®2).

Use the directional buttons to select the  (Help) icon, and press the X button. The list of button functions is displayed. The display is turned on and off each time you press the X button.

Finding a particular point on a disc (Search)

You can use the Search function to quickly locate a particular point on a DVD. You can search either forward or backward and can switch between 3 speeds and slow-motion playback speed. This function is also available using the Analog Controller (DUALSHOCK®2) when the Control Panel is not displayed.

1 During playback, use the directional buttons to select the  (Search, Fast Reverse) or  (Search, Fast Forward) icon. Then press and hold down the X button to begin searching. Press the directional buttons to change speeds while searching.

Search speed changes as shown below when you press the directional buttons while holding down the X button.

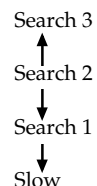

2 Release the X button when you reach the point you are searching for.

Playback returns to normal speed.

Using the Analog Controller (DUALSHOCK®2)

1 During playback, press and hold down the L2 or R2 button to begin searching. Press the directional buttons to change speeds while searching.

Search speed changes as shown below when you press the directional buttons while holding down the L2 or R2 button.

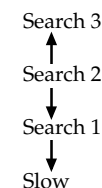



2 Release the L2 or R2 button when you reach the point you are searching for.

Playback returns to normal speed.

Note

This function may not be available on some DVDs.

Playing in slow-motion

During playback, use the directional buttons to select the  (Slow Backward) or  (Slow Forward) icon, and press the X button. Slow-motion playback begins.

To end slow-motion playback

Use the directional buttons to select the  (Play) icon, and press the X button. Playback returns to normal speed.

Using the Setup display

You can adjust the picture and sound settings, and set various other output options using the Setup display. You can also select a language for subtitles and menus, restrict playback by children, and so on. For details on the Setup display, see pages 20-23.

Before using the Setup display

Some menu items cannot be selected during Resume Play as noted on the pages that follow. For details on clearing Resume Play, see "To clear Resume Play" on page 15.

1 Use the directional buttons to select the (Setup) icon, and press the X button.

The Setup icon bar is displayed, giving you access to the menu items shown on this page.

2 Use the directional buttons to select the icon for the setting you would like to change, and press the X button.

The menu for the icon selected is displayed.

3 Use the directional buttons to choose a menu item, and press the X button.

The options for the menu item selected are displayed.

4 Use the directional buttons to select an option, and press the X button.

The option selected is set.

After using the Setup Display

To save changes made during playback, you must stop playback* or eject the DVD before pressing the  (standby)/RESET button on the console front or turning off the console using the MAIN POWER switch on the console rear. Note that changes will not be saved if you reset or turn off the console before stopping playback, or without first ejecting the DVD.

* Stopping playback during Resume Play is included.

Setup display menus

The Setup display menus are organized as shown below. The default settings are underlined.

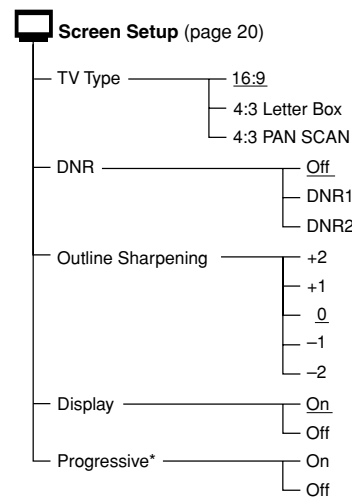
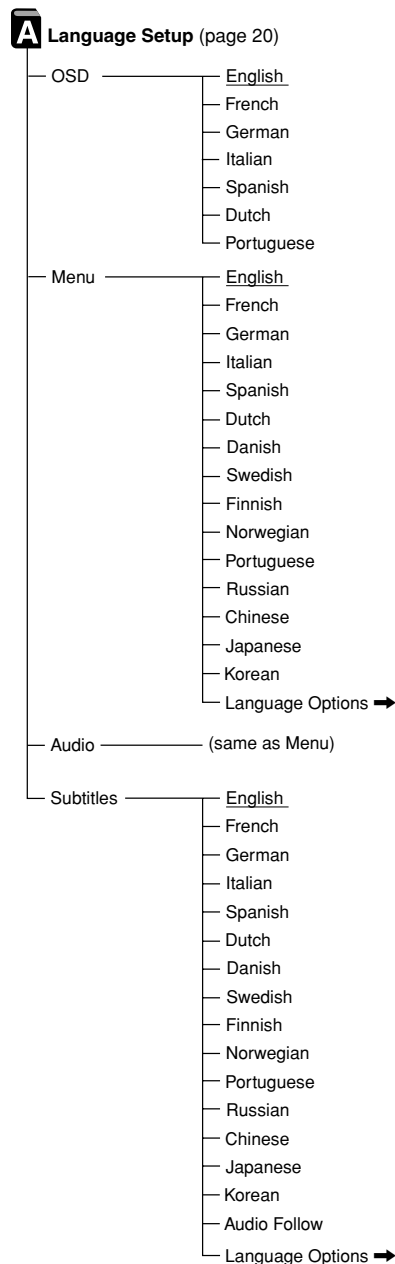

* Progressive is only available when playing a disc recorded in NTSC format, and viewed on a TV that supports NTSC signals. This setting option will not be displayed when the disc is recorded in PAL format.

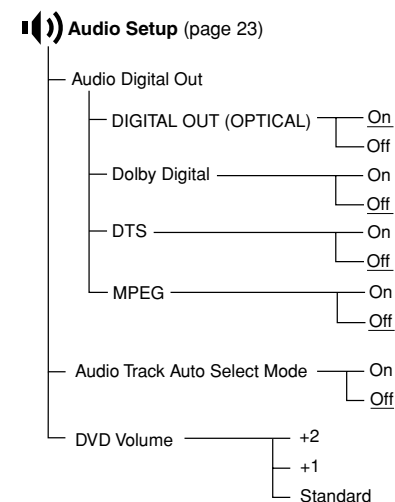
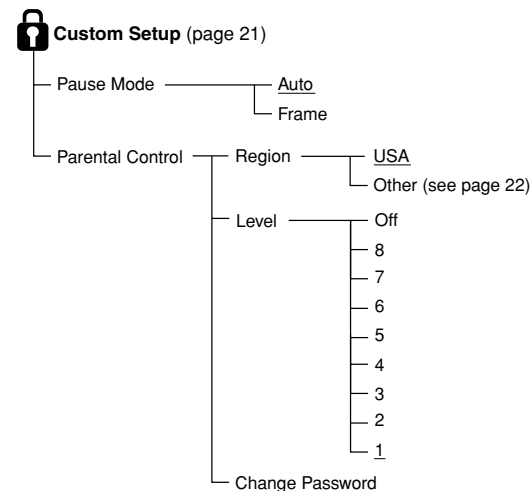

Setting language options (Language Setup)

“Language Setup” allows you to choose from among various languages for the on-screen display (OSD), DVD audio, and other items. The default setting for each menu item is underlined in the explanations below.

Select the  (Language Setup) icon in the Setup display. For details, see “Using the Setup display” on page 19.

Notes

- When you select a language that is not recorded on the DVD, one of the recorded languages is automatically selected for the “Menu,” “Audio” and “Subtitles” settings.
- Depending on the DVD, the language you have selected for the “Menu,” “Audio” or “Subtitles” may not be used.

OSD

Selects the language for the on-screen display.

- English
- French
- German
- Italian
- Spanish
- Dutch
- Portuguese

Menu

Selects the language for the DVD disc menu. This setting is not available during Resume Play.

- English
- French
- German
- Italian
- Spanish
- Dutch
- Danish
- Swedish
- Finnish
- Norwegian
- Portuguese
- Russian
- Chinese
- Japanese
- Korean
- Language Options*

* When you select “Language Options,” you can choose from an extensive list of languages.

Audio

Selects the language for the audio track. This setting is not available during Resume Play.

- English
- French
- German
- Italian
- Spanish
- Dutch
- Danish
- Swedish
- Finnish
- Norwegian
- Portuguese
- Russian
- Chinese
- Japanese
- Korean
- Language Options*

* When you select “Language Options,” you can choose from an extensive list of languages.

Subtitle

Selects the language for the subtitles. This setting is not available during Resume Play.

- English
- French
- German
- Italian
- Spanish
- Dutch
- Danish
- Swedish
- Finnish
- Norwegian
- Portuguese
- Russian
- Chinese
- Japanese
- Korean
- Audio Follow¹
- Language Options²

¹ When you select “Audio Follow,” the language for subtitles automatically changes to match the language you have selected for the audio track.

² When you select “Language Options,” you can choose from an extensive list of languages.

Setting TV display options (Screen Setup)

You can set the aspect ratio and other display options for the connected TV using this setting. The default setting for each menu is underlined in the explanations below.

Select the  (Screen Setup) icon in the Setup display. For details, see “Using the Setup display” on page 19.

TV Type

Sets the aspect ratio of the TV. This setting is not available during Resume Play.

- 16:9: Select this option when using a wide-screen TV, or a standard TV that displays in wide mode.
- 4:3 Letter Box: Select this option when using a standard TV. This setting displays a wide picture with margins on the upper and lower portions of the screen.
- 4:3 PAN SCAN: Select this option when using a standard TV. This setting displays a wide picture adjusted to the height of the screen, cutting off the portions at left and right that do not fit.

16:9

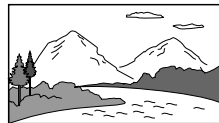

4:3 Letter Box



4:3 PAN SCAN

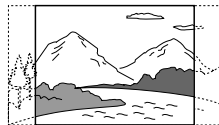

Notes

- Some DVDs may automatically set the aspect ratio of the TV.
- When “Progressive” is set to “On,” the aspect ratio of the TV is set to 16:9 and cannot be changed.

■ DNR (Digital Noise Reduction)

This setting may help reduce roughness in the on-screen image and produce a cleaner picture.

- **Off:** Normally select this position.
- **DNR1:** Increases picture clarity.
- **DNR2:** Increases picture clarity (maximum).

Notes

- DNR2 is more effective for reducing image roughness than DNR1, but in some cases an afterimage may appear. If this occurs, select "Off."
- The DNR function may produce limited results on some DVDs.
- When "Progressive" is set to "On", DNR is automatically turned off and cannot be turned on.

■ Outline Sharpening

You can sharpen or soften the outline of the on-screen image using this setting. The higher the value, the sharper the outline.

- +2
- +1
- 0: Normally select this position.
- -1
- -2

■ Display

You can display or turn off playback status information in the top right corner of the screen.

- **On:** When playing a DVD, the playback status information is displayed for a few seconds.
- **Off:** Playback status information is not displayed.

■ Progressive

The DVD player's progressive mode is only available when playing a disc recorded in NTSC format, and viewed on a TV that supports NTSC signals.

This setting is not available during Resume Play.

- **On:** Select this when the console is connected to a TV that supports progressive scan.
- **Off:** Select this when the console is connected to a normal TV.

Notes

- To use progressive scan you must have a TV that supports progressive scan and you must connect your console using the SCPH-10100 E Component AV Cable (for PlayStation®2), which is sold separately.
- If you set "Progressive" to "On" without the necessary equipment, picture quality may be reduced, or the picture may not be displayed.
- If you accidentally set this option to "On" and need to clear the setting, with the DVD inserted in the console press the (standby)/RESET button on the console front. Then hold down the START button on the Analog Controller (DUALSHOCK®2) inserted into controller port 1 until the DVD picture is displayed. When DVD playback begins, "Progressive" will be set to "Off", allowing the DVD video to be displayed as normal. "Progressive" can also be set to "Off" in the Version Information screen. See page 8 for details.
- Progressive scan is not available when playing a DVD-RW disc with content recorded in VR mode.
- When playing video material using progressive scan, some video images may appear unnatural. This is due to an image conversion process. If this occurs, set "Progressive" to "Off", and view in standard interlace mode. For details on video material, see "Video material" in the Glossary on page 27.

Setting viewer options (Custom Setup)

You can set the Parental Control level and adjust other playback features using Custom Setup.

The default setting for each menu is underlined in the explanations below.

Select the **Custom Setup** icon in the Setup display. For details see "Using the Setup display" on page 19.

■ Pause Mode

Sets the picture status in pause mode.

- **Auto:** A picture with a lot of moving elements can be displayed without jitter. Normally select this position.
- **Frame:** A picture without a lot of moving elements can be displayed in high resolution.

■ Parental Control

The viewing of some DVD content may be restricted based on viewer age or other factors in some regions. You can use the Parental Control feature to restrict the level of content that may be viewed on your console.

This setting is not available during Resume Play.

Setting Parental Control

Select the **Custom Setup** icon in the Setup display.

1 Use the directional buttons to select "Parental Control", and press the **X** button.

If you have not registered a password
The screen for registering a password is displayed.

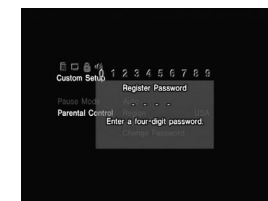

If a password has already been registered

The screen for confirming the password is displayed.

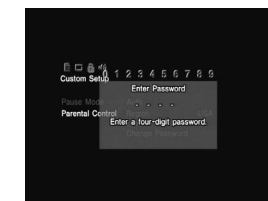

2 Use the directional buttons to select a number, and press the **X** button. Repeat this step to enter a four-digit password.

The screen for setting the region, Parental Control level, and for changing your password is displayed.

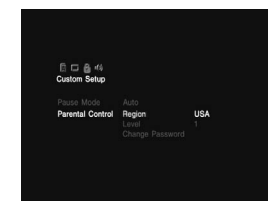

- 3** Use the directional buttons to select "Region", and press the **X** button.



- 4** Use the directional buttons to select the region to base Parental Control levels on, and press the **X** button.

If you select "Other", refer to the "Region code list" at right for the region code to select.

Use the directional buttons to select the first letter, and press the right directional button. Use the directional buttons to select the second letter, and press the **X** button.

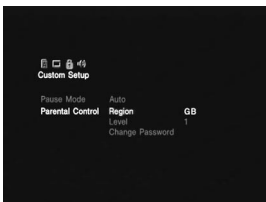

- 5** Use the directional buttons to select "Level", and press the **X** button.

The list of level options is displayed.



- 6** Use the directional buttons to select a restriction level, and press the **X** button.

Parental Control is set.

The lower the value, the stricter the restriction.

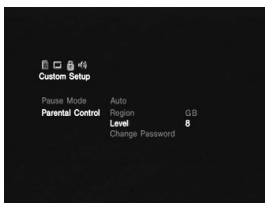

Region code list

Region	Code	Region	Code
Austria	AT	Malaysia	MY
Belgium	BE	Netherlands	NL
Canada	CA	Norway	NO
China	CN	Philippines	PH
Denmark	DK	Russia	RU
Finland	FI	Singapore	SG
France	FR	Spain	ES
Germany	DE	Sweden	SE
Hong Kong	HK	Switzerland	CH
Indonesia	ID	Taiwan	TW
Italy	IT	Thailand	TH
Japan	JP	United Kingdom	GB
Korea	KR		

To change your password

- 1** In step 2 under "Setting Parental Control" use the directional buttons to select "Change Password", and press the **X** button.

The screen for changing the password is displayed.

- 2** Use the directional buttons to select a number, and press the **X** button. Repeat this step to enter a four-digit password.

To confirm your password, enter it once again. The password is changed.

Playing a disc which is restricted by Parental Control

- 1** Insert the disc.

Playback begins automatically, and at the point where Parental Control is set, the screen changes to a display requesting confirmation to temporarily change the Parental Control level.

- 2** Use the directional buttons to select "Yes", and press the **X** button.

The screen for confirming the password is displayed.

- 3** Use the directional buttons to select a number, and press the **X** button. Repeat this procedure to enter the four-digit password.

Playback begins.

When DVD playback is stopped, the Parental Control level returns to the original setting.

If you forget your password

- 1** Press the SELECT button when the screen for confirming the password is displayed.

The screen for deleting the password is displayed.

- 2** Use the directional buttons to select a number, and press the **X** button. Repeat this procedure to enter the four-digit number "7444".

The current password is deleted and the screen for registering a new password is displayed.

- 3** Follow step 2 in "Setting Parental Control", to register a new password.

Notes

- If you play a DVD that does not have the Parental Control function, playback will not be restricted even if you set a playback restriction level on your console.
- If you do not set a password, you cannot change the Parental Control settings.
- Some DVDs may require you to enter only the password without changing the Parental Control level.
- Program Play, Shuffle Play, Repeat Play, and A-B Repeat may not be available on some DVDs with the Parental Control feature.

To clear Parental Control

With DVD playback stopped, go to step 6 in "Setting Parental Control" and set "Level" to "Off".

This setting cannot be cleared during Resume Play.

Setting sound options (Audio Setup)

You can adjust your audio settings based on the playback conditions or the equipment in use.

The default setting for each menu is underlined in the explanations below. For details see “Using the Setup display” on page 19.

Select the  (Audio Setup) icon in the Setup display.

■ Audio Digital Out

You can switch the methods of outputting audio signals when you connect the following audio devices to the DIGITAL OUT (OPTICAL) connector on the PlayStation®2 console rear using an optical digital cable (sold separately).

- A digital device such as a receiver (amplifier) with a digital connector.
- An audio device with a built-in Dolby Digital or DTS decoder.
- A DAT (Digital Audio Tape) or MD (MiniDisc) deck. For connection details, see page 6.

■ DIGITAL OUT (OPTICAL)

Selects whether to output signal through the DIGITAL OUT (OPTICAL) connector.

- On: Select this when you connect with an optical digital cable (sold separately). Normally select this option. If you select “On”, make the appropriate settings for “Dolby Digital”, “DTS” and “MPEG”.
- Off: Select this when you do not want sound (audio signal) to be output through the DIGITAL OUT (OPTICAL) connector.

Note

If you select “Off”, you cannot set “Dolby Digital”, “DTS” or “MPEG”.

■ Dolby Digital

Selects the Dolby Digital signal to be output through the DIGITAL OUT (OPTICAL) connector.

- On: Select this option when the console is connected to an audio device with a built-in Dolby Digital decoder. If the console is connected to an audio device without a built-in Dolby Digital decoder, do not turn this option on. If you select this option by mistake, when you play a Dolby Digital audio track, a loud noise (or no sound) will come out from the speakers, possibly hurting your ears or damaging the speakers.
- Off: Select this option when the console is connected to an audio device without a built-in Dolby Digital decoder.

■ DTS

Selects the DTS signal to be output through the DIGITAL OUT (OPTICAL) connector when you connect to the console with an optical digital cable (sold separately).

This setting is not available during Resume Play.

- On: Select this option when the console is connected to an audio device with a built-in DTS decoder. If the console is connected to an audio device without a built-in DTS decoder, do not turn this option on. If you select this option by mistake, when you play a DTS audio track, a loud noise (or no sound) will come out from the speakers, possibly hurting your ears or damaging the speakers.
- Off: Select this option when the console is connected to an audio device without a built-in DTS decoder.

■ MPEG

Selects the MPEG AUDIO signals to be output via the DIGITAL OUT (OPTICAL) connector.

- On: Select this option when the console is connected to an audio device with a built-in MPEG decoder. If the console is connected to an audio device without a built-in MPEG decoder, do not turn this option on. If you select this option by mistake, when you play an MPEG audio track, a loud noise (or no sound) will come out from the speakers, possibly hurting your ears or damaging the speakers.
- Off: Select this option when the console is connected to an audio device without a built-in MPEG decoder.

■ Audio Track Auto Select Mode

Gives the audio track that contains the highest number of channels priority when you play a DVD on which multiple audio formats (PCM, Dolby Digital, DTS or MPEG AUDIO) are recorded.

This setting is not available during Resume Play.

- On: Priority given
- Off: No priority given

Notes

- If you set this item to “On”, the language may change because the “Audio Track Auto Select Mode” setting has higher priority than the “Audio” settings in “Language Setup” (page 20).
- If you set “DIGITAL OUT (OPTICAL)” to “On” and “DTS” to “Off” in “Audio Setup”, the DTS audio track is not played even if you set this item to “On” and the highest-numbered audio channel is recorded in DTS format.
- If PCM, Dolby Digital, DTS and MPEG audio tracks have the same number of channels, the console selects PCM, Dolby Digital, DTS and MPEG audio tracks in this order.
- Depending on the DVD, the audio channel with priority may be predetermined. In this case, you cannot give priority to the Dolby Digital, DTS or MPEG format by selecting “On”.

■ DVD Volume

If the audio output level of the DVD is low, you can turn up the volume of the DVD. DIGITAL OUT (OPTICAL) must be set to “Off” to change this setting.

- +2: Turns up the volume (maximum).
- +1: Turns up the volume.
- Standard: Original audio volume. Normally select this position.

Note

If you set this option to “+1” or “+2”, the sound may be distorted in places where loud sound is present. If the sound becomes distorted, select “Standard”.

Caution

If you turn up the volume too high, your ears may be injured or the speakers may be damaged.

This product incorporates copyright protection technology that is protected by method claims of certain U.S. patents and other intellectual property rights owned by Macrovision Corporation and other rights owners. Use of this copyright protection technology must be authorized by Macrovision Corporation, and is intended for home and other limited viewing uses only unless otherwise authorized by Macrovision Corporation. Reverse engineering or disassembly is prohibited.



Please double check

- **If you experience any of the following difficulties while using the console, use this troubleshooting guide to help remedy the problem. Should any problem persist, please contact the appropriate PlayStation® customer service helpline which can be found within every PlayStation® and PlayStation®2 format software manual.**
- **Make sure the AC power cord is connected to the console and the mains, and the TV (or VCR) or the supplied accessories are connected to the console correctly.**
- **In rare instances, certain DVD videos may not operate properly with PlayStation®2. This is primarily due to variations in the manufacturing process or software encoding of the DVD video software. If you experience problems, try restarting your DVD video. If problems persist, for more information call the publisher of the DVD video or contact the appropriate PlayStation® customer service helpline which can be found within every PlayStation® and PlayStation®2 format software manual.**

Power

The power is not turned on.

- ➔ Check that the AC power cord is connected securely.
- ➔ The console is not turned on. Turn on the console using the MAIN POWER switch on the console rear.

Picture

There is no picture.

- ➔ Check that the console is connected to the TV (or VCR) with the AV Cable (integrated audio/video).
- ➔ Check that the console and the TV (or VCR) are turned on.
- ➔ Check that you have selected the video input on the TV (or VCR).
- ➔ Check that the AV Cable (integrated audio/video) is connected securely.
- ➔ Check that the inserted disc can be played with this console (see page 3).
- ➔ Check that the disc is placed with the label side facing up (when using a disc with a label).
- ➔ The disc is not inserted correctly.
- ➔ DVD playback has been stopped.
- ➔ Try another set of AV Cables.

Picture noise appears.

- ➔ The console is placed on an unstable surface. Place the console on a stable and flat surface. Do not shake or vibrate the console.
- ➔ Clean the disc.
- ➔ Moisture has condensed inside the console (see page 2).
- ➔ If the video signal from the console has to go through the VCR to get to the TV, the copy protection applied to some DVD videos could affect picture quality. When playing a DVD video, connect the console to the TV directly (see pages 5-6).
- ➔ The progressive scan option is set to "On" when using a TV that does not support progressive scan, or when using a cable other than the Component AV Cable (for

PlayStation®2). Do not open the disc tray or remove the DVD. With the DVD inserted in the console, press the ⏻ (standby)/RESET button on the console front. Then hold down the START button on the Analog Controller (DUALSHOCK®2) inserted into controller port 1 until the DVD picture is displayed. When DVD playback begins, "Progressive" will be set to "Off", allowing the DVD video to be displayed as normal. "Progressive" can also be set to "Off" in the Version Information screen. See page 8 for details.

- ➔ Some video images appear unnatural when using progressive scan, even when the TV supports progressive mode. Set "Progressive" to "Off", and view in standard interlace mode.

The aspect ratio cannot be changed according to the TV when playing wide screen DVD videos.

- ➔ Depending on the disc, the aspect ratio is fixed.
- ➔ Check that the console is connected to the TV directly. (The selector or receiver (amplifier) may be connected between the console and the TV.)
- ➔ Depending on the TV, the aspect ratio is fixed.

When playing a DVD-RW disc recorded in VR mode, the message "Playback is restricted. Cannot play." is displayed on the screen and then the screen turns blue.

- ➔ You may be playing a disc that contains "copy-once" content. Video recorded on CPRM-compatible DVD-RW discs using the copy-once feature cannot be played back. For details, see "Notes on the playback of DVD-R/DVD-RW/DVD+R/DVD+RW discs*" on page 3.

Sound

There is no sound.

- ➔ Check that the console is connected to the TV (or VCR) with the AV Cable (integrated audio/video).
- ➔ Check that the console and the TV (or VCR) are turned on.
- ➔ Check that you have selected the video input on the TV (or VCR).
- ➔ Check that the TV volume is set properly or "mute" is not selected on the TV.
- ➔ Check that the AV Cable (integrated audio/video) is connected securely.
- ➔ Check that the inserted disc can be played with this console (see page 3).
- ➔ Check that the disc is placed with the label side facing up (when using a disc with a label).
- ➔ Check that you have connected the console to the audio input connectors on the receiver (amplifier) correctly. Refer also to the instructions supplied with your amplifier.
- ➔ Try another set of AV Cables.
- ➔ Check the speaker connections and settings. Refer to the instruction manual supplied with your receiver (amplifier).
- ➔ Check that you select the appropriate input on the receiver (amplifier) so that you can listen to sound from the console. Refer also to the instructions supplied with your amplifier.
- ➔ The console is in pause mode.
- ➔ The console is in search/slow-motion mode (when playing a DVD video).
- ➔ You are playing an audio CD or DVD with a DTS audio track. Do not play back DTS audio tracks when the console is connected to an audio device without a built-in DTS decoder (see page 23).
- ➔ The system setting is not correct for when the console is connected to audio equipment with DIGITAL OUT (OPTICAL) connectors (see page 6).

Poor sound quality.

- ➔ The console is placed on an unstable surface. Place the console on a stable and flat surface. Do not shake or vibrate the console.
- ➔ Clean the disc.
- ➔ Moisture has condensed on the disc (see page 2).
- ➔ You are playing an audio CD or a DVD with DTS sound tracks. You can play an audio CD or a DVD with DTS sound tracks only when the console is connected to audio equipment with a built-in DTS decoder.

The surround effect is difficult to hear when you are playing a DVD video with a Dolby Digital sound track.

- ➔ Check the speaker connections and settings. Refer to the instruction manual supplied with your receiver (amplifier).
- ➔ Depending on the DVD, the output signal may not comprise of the entire 5.1 channel range. It may be monaural or stereo even if the sound track is recorded in Dolby Digital.

The sound comes from the centre speaker only.

- ➔ Depending on the disc, the sound may come from the centre speaker only.

Operation**The controller does not function.**

- ➔ Check that the controller is connected to the console.
- ➔ Check that the Analog Controller (DUALSHOCK®2) or the Analog Controller (DUALSHOCK®) is set to the appropriate mode for the software (see page 10).
- ➔ Try another controller.
- ➔ Try setting the "Remote Control" setting of the System Configuration menu to "Gameplay Function Off".

Some unlicensed 3rd party peripherals may not operate with "Gameplay Function" set to "On". Note that use of such peripherals is not recommended and will void your warranty.

The software title does not start.

- ➔ Check that the inserted disc can be played with this console (see page 3).
- ➔ Check that the disc is placed with the label side facing up (when using a disc with a label).
- ➔ Check that the disc is inserted correctly.
- ➔ Clean the disc.
- ➔ Moisture has condensed on the disc (see page 2).
- ➔ Try another copy of the disc.
- ➔ Check that the DVD-R or DVD-RW you are playing has been finalized.

You cannot save data on the Memory Card (8MB) (for PlayStation®2) or Memory Card.

- ➔ Check that the Memory Card (8MB) (for PlayStation®2) or Memory Card is inserted securely.
- ➔ Check that you are playing the game correctly. Refer to the appropriate software manual.
- ➔ Check that there are empty blocks/free space on the Memory Card (8MB) (for PlayStation®2) or Memory Card.
- ➔ Try another Memory Card (8MB) (for PlayStation®2) or Memory Card.

The console does not function properly.

- ➔ Static electricity, etc. may affect the console's operation. Turn off the MAIN POWER switch and then turn it back on.

The  indicator flashes in red and the console does not work.

- ➔ A flashing red light indicates a console "fault" condition and the unit will not operate. Remove any obstructions from the vents to allow the console to cool down. Resume play after the console returns to standby mode.

The disc tray does not open.

- ➔ Check that the AC power cord is connected securely.
- ➔ Check that the console is turned on. Turn on the console using the MAIN POWER switch on the back of the console.

DVD video operation**The console does not play from the beginning when playing a disc.**

- ➔ Resume Play has been selected. Select the  (Stop) icon and press the X button twice before you start playing (see page 15).
- ➔ Depending on the disc, a DVD disc menu is automatically displayed.

The disc does not play even if the DVD title is selected.

- ➔ A Parental Control limit has been set on the disc (see page 21).

Playback stops automatically.

- ➔ The disc may contain an auto pause signal. While playing such a disc, the console stops playback at the signal.

You cannot perform some functions such as Stop, Search or slow-motion play, Program Play, Shuffle Play or Repeat Play.

- ➔ Depending on the disc, you may not be able to do some of the operations above.

The language for the sound track cannot be changed.

- ➔ Multilingual tracks are not recorded on the DVD.
- ➔ Changing the language for the track is prohibited on the DVD.

The subtitle language cannot be changed.

- ➔ Multilingual subtitles are not recorded on the DVD.
- ➔ Changing the language for the subtitles is prohibited on the DVD.

The subtitles cannot be turned off.

- ➔ Depending on the DVD, you may not be able to turn the subtitles off.

The angles cannot be changed when you play a DVD.

- ➔ Multi-angles are not recorded on the DVD.
- ➔ Changing the angles is prohibited on the DVD.

The  icon cannot be selected.

- ➔ Insert a DVD-RW (VR mode) disc in the console (see page 17).

General

- Power requirements
 - 220-240 V AC, 50/60 Hz
- Power consumption
 - 50 W
- Dimensions (approx.)
 - 301 × 78 × 182 mm (w/h/d)
- Mass (approx.)
 - 2.0 kg
- Operating temperature
 - 5°C-35°C
- Laser diode properties
 - Material: GaAlAs
 - Wavelength: λ=650/780 nm

Inputs/outputs on the console front

- Controller port (2)
- MEMORY CARD slot (2)
- ψ USB connector (2)

Inputs/outputs on the console rear

- AV MULTI OUT connector (1)
- DIGITAL OUT (OPTICAL) connector (1)
- EXPANSION BAY (1)

Supplied accessories

See page 4.

Optional accessories

- SCPH-110 E Analog Controller (DUALSHOCK®)
- SCPH-1020 EHI Memory Card
- SCPH-1090 E Mouse
- SCPH-10010 E Analog Controller (DUALSHOCK®2)
- SCPH-10020 E Memory Card (8MB) (for PlayStation®2)
- SCPH-10030 E AV Cable (integrated audio/video)
- SCPH-10040 E Vertical Stand (for PlayStation®2)
- SCPH-10060 E S VIDEO Cable
- SCPH-10072 C RFU Adaptor
- SCPH-10090 E Multitap (for PlayStation®2)
- SCPH-10100 E Component AV Cable (for PlayStation®2)
- SCPH-10110 E Horizontal Stand (for PlayStation®2)
- SCPH-10130 E AV Adaptor (with S VIDEO OUT connector)
- SCPH-10420 E DVD Remote Control (for PlayStation®2)

Design and specifications are subject to change without notice.

Chapter (page 18)

Sections of a movie or a music piece on a DVD that are smaller than titles. A title is composed of several chapters. Each chapter is assigned a chapter number enabling you to locate the chapter you want.

Dolby Digital (page 23)

Digital audio compression technology developed by Dolby Laboratories. This technology conforms to 5.1-channel surround sound. The rear channel is stereo and there is a discrete subwoofer channel in this format. Dolby Digital provides the same 5.1 discrete channels of high quality digital audio found in Dolby Digital cinema audio systems. Good channel separation is realised because all of the channel data is recorded discretely and processed in digital.

DTS (page 23)

Digital audio compression technology that Digital Theater Systems, Inc. developed. This technology conforms to 5.1-channel surround sound. The rear channel is stereo and there is a discrete subwoofer channel in this format. DTS provides the same 5.1 discrete channels of high quality digital audio. Good channel separation is realised because all of the channel data is recorded discretely and processed in digital.

DVD video (page 3)

DVD video discs can contain up to 8 hours of moving pictures on a disc with the same diameter as a CD. The picture data uses the MPEG 2 format, one of the worldwide standards of digital compression technology. Audio data is recorded in a multi-channel format allowing you to enjoy a more real audio presence. DVD video discs also can contain advanced functions such as multiple viewing angles, multilingual tracks and Parental Control playback restrictions.

DVD-RW (page 3)

DVD-RW is a recordable and rewritable disc that is the same size as a DVD VIDEO disc. DVD-RW discs have two modes: VR mode and Video mode.

- Video mode - complies with DVD-VIDEO format and is compatible with most DVD players once finalized, whereas a DVD-RW recorded in VR mode can only be played on DVD-RW compliant DVD players.
- VR (Video Recording) mode - enables various programming and editing functions, some of which are not available in Video mode.

DVD+RW (page 3)

DVD+RW (read "plus RW") is a recordable and rewritable disc. DVD+RW discs use a recording format that is comparable to the DVD VIDEO format.

MPEG AUDIO (page 23)

International standard coding system to compress audio digital signals authorised by ISO/IEC.

Multi-angle function (page 17)

Various angles for the scene (viewpoints of the video camera) are recorded on some DVDs.

Multilingual function (page 17)

Several languages for the audio track or subtitles in a picture are recorded on some DVDs.

Parental Control (page 21)

A function of the DVD used to limit playback of the disc according to the age of the user and the limitation level in each country. The limitation varies from disc to disc; when it is activated, playback can be completely prohibited, violent scenes are skipped or replaced with other scenes, and so on.

Progressive scan (NTSC) (page 21)

Compared to standard interlace mode that alternatively shows every other line of an image to create one frame, progressive scan shows the entire image at once as a single frame. This means that while interlace mode can show 30 frames per second, progressive scan can show 60. The overall picture quality increases and still images, text and horizontal lines appear sharper.

Title (page 18)

The longest section of a movie or a music piece on a DVD; a movie, etc., for a picture piece on video software; or an album, etc., for a music piece on audio software. Each title is assigned a title number enabling you to locate the title you want.

Video material (NTSC) (page 21)

DVD material can be divided into two types: video based material and film based material. Video based material is recorded at 30 frames (60 fields) per second, and is normally used for TV programs and cartoons. Film based material is recorded at 24 video images per second, and is used for most movies. Some DVDs contain both video based and film based material.

GUARANTEE

Thank you for buying this Product.

Sony Computer Entertainment Europe ("SCEE") will, for a period of 1 (one) year from the date of original purchase, repair or (at SCEE's option) replace any component part of this Product, free of charge, where it is faulty due to defective materials or workmanship. Replacement will be with a new or refurbished component or unit, at SCEE's option.

The benefits conferred by this Guarantee are in addition to other rights and remedies which the consumer has in law in Australia in respect of this Product, including rights and remedies available under the Trade Practices Act 1974 and State and Territory legislation.

Sony Computer Entertainment Europe
30 Golden Square, London
W1F 9LD UK

IMPORTANT



1. If you need to claim under this Guarantee, please call your local Customer Service Helpline (listed on the Customer Registration Card and in a current software manual) for return instructions and other guidance.
2. This Guarantee is only valid:
 - (i) in Australia and New Zealand;
 - (ii) when the original sales receipt or invoice (indicating the date of purchase and retailer's name) is presented together with the faulty Product (and has not been altered or defaced since the date of original purchase);
 - (iii) when the Guarantee seal on the Product has not been damaged or removed.

3. You may not claim under this Guarantee when the Product is damaged as a result of:
 - (i) commercial use, accident, fair wear and tear or misuse (including, without limitation, failure to use this Product for its normal purpose and/or in accordance with instructions on proper use and maintenance, or installation or use in a manner inconsistent with applicable local technical or safety standards);
 - (ii) use in conjunction with any unauthorised peripheral (including, without limitation, game enhancement devices, adaptors and power supply devices);
 - (iii) any adaptation or adjustment to, or alteration of, this Product carried out for any reason, and whether properly carried out or not;
 - (iv) maintenance or repairs carried out other than by an authorised service facility.
4. Where permitted under applicable law, this Guarantee will be your sole and exclusive remedy for breach of any warranty, guarantee or condition, express or implied, in respect of this Product and neither SCEE nor any other Sony entity, or their suppliers or authorised service facilities, will be liable for any incidental or consequential loss or damage.

If this Product needs any repair which is not covered by this Guarantee, please call your local Customer Service Helpline for advice. If your home country is not one of those listed, please contact your retailer.

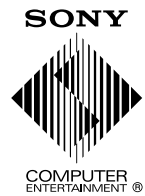
Please complete and return the enclosed (Freepost) Customer Registration Card.



“”, “PlayStation”, “”, “DUALSHOCK” and “” are registered trademarks of Sony Computer Entertainment Inc.
“SONY” and “” are registered trademarks and **MAGICGATE** is a trademark of Sony Corporation.